

Produktvorteile



Euromas II stellt nicht nur optisch eine Alternative zum klassischen Industriegehäuse Euromas dar. Ein besonderes Augenmerk wurde auf die zahlreichen Montagemöglichkeiten für Leiterplatten und Tastaturen gelegt.



Die F-Versionen verfügen über eine vertiefte Fläche im Oberteil für die bündige Montage von Folientastaturen.



Befestigungsdomen für Leiterplatten sind nicht nur im Unterteil, sondern auch im Deckel vorhanden.



Die Unterteile sind modellabhängig mit zusätzlichen speziell abgestimmten Befestigungen für Tragschienen oder Klemmleisten ausgerüstet.



Für die vertikale Montage von Leiterplatten stehen die LP-Versionen zur Verfügung.



Quick-Finder:
www.bopla.de/62

Anwendungsbeispiele





BOPLA

A Phoenix Mecano Company

Euromas II

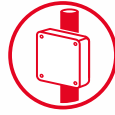

Farbton:

● Lichtgrau, ähnlich RAL 7035

Sonderfarben auf Anfrage

Schutzart:

IP65 / DIN EN 60529

Material:

Gehäuse: ABS oder PC (UV-stabilisiert),

Dichtung: CR

Details siehe „Technische Informationen“.



Gehäusegrößen

EM / ET 205



EM / ET 206



EM / ET 208

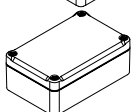

EM / ET 210

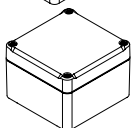

EM / ET 212

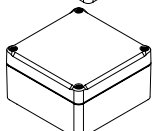

EM / ET 213

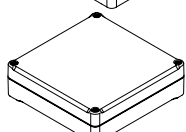

EM / ET 215

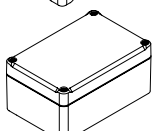

EM / ET 217

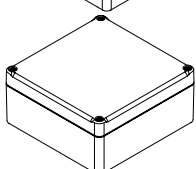

EM / ET 220

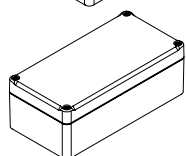

EM / ET 221

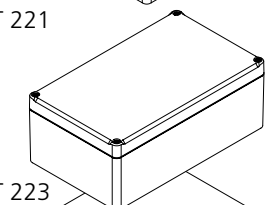

EM / ET 223

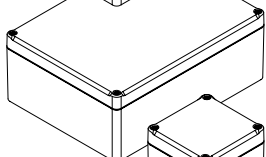

EM / ET 225

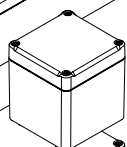

EM / ET 227

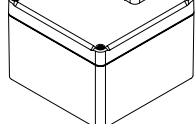

EM / ET 229

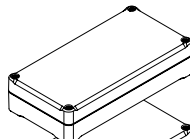

EM / ET 231

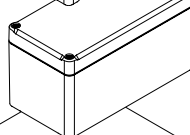

EM / ET 232

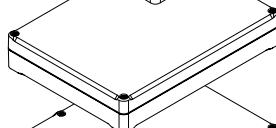

EM / ET 233

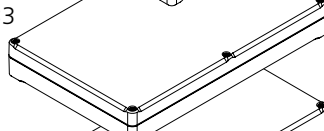

EM / ET 237

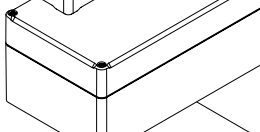

EM / ET 238



EM / ET 239

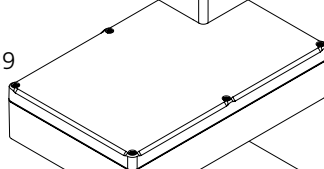

EM / ET 240

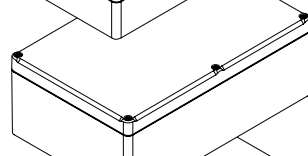

EM / ET 241

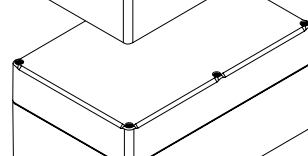

EM / ET 242

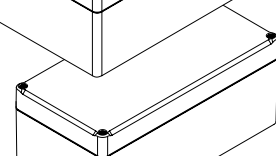

EM / ET 247

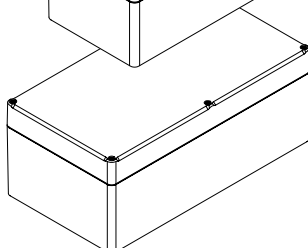

Bauvarianten

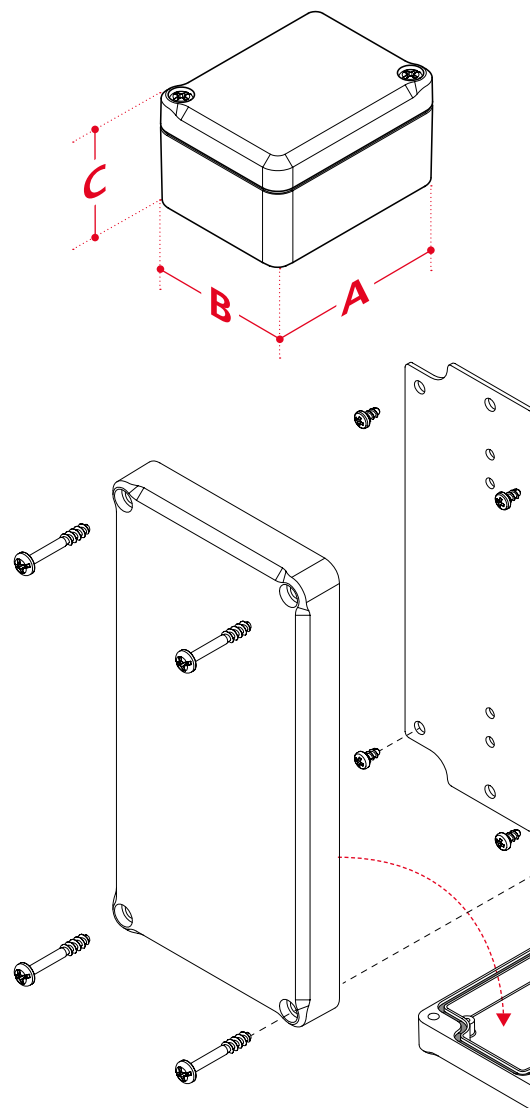

Integrierte Domreihe

zur direkten Montage
 von Klemmenblöcken

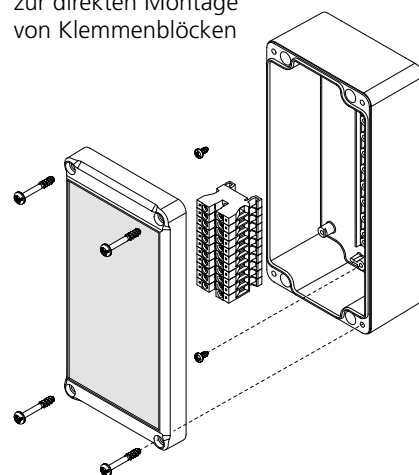

Euromas II

EM-WL

Alternativ Wandlaschen
anschraubbar

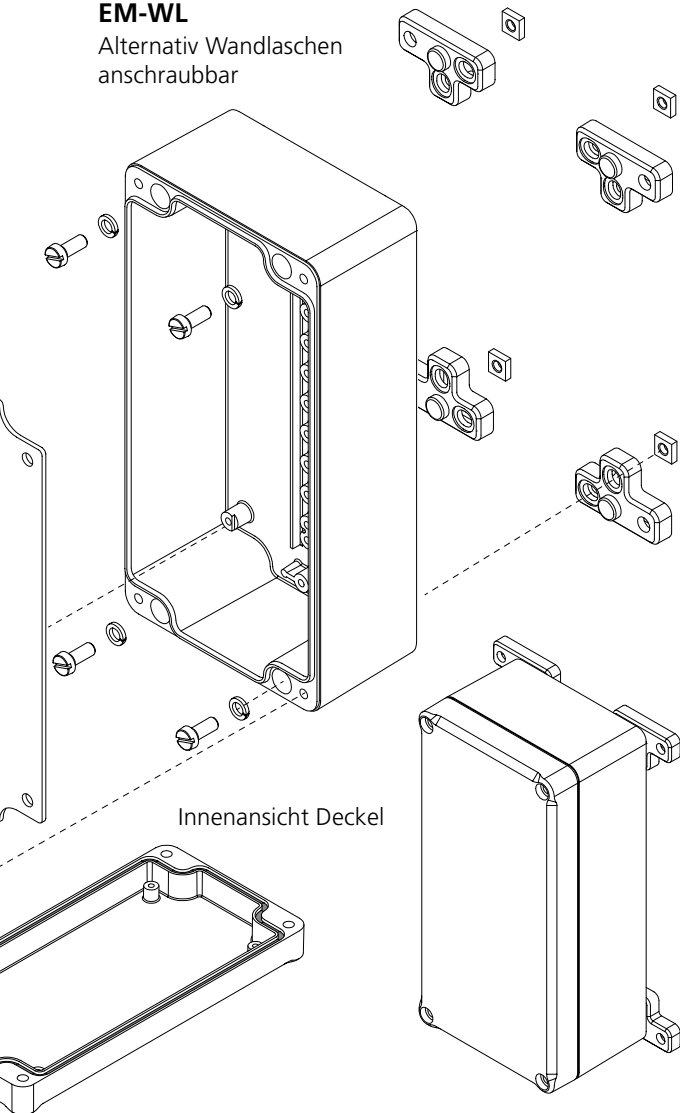

Innenansicht Deckel

Variante EM / ET...LP

mit Nuten für die vertikale
Montage von Leiterplatten

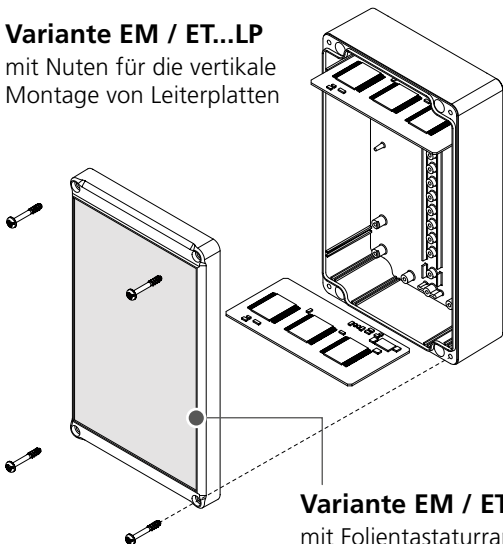

Variante EM / ET...F
mit Folientastaturrand

Abmessungen

Modell	A	B	C	F	LP	F+LP
EM / ET 205	74	50	37	✓		
EM / ET 206	65	50	37	✓		
EM / ET 207	82	60	57		✓	✓
EM / ET 208	98	64	38	✓		
EM / ET 210	82	80	57	✓		
EM / ET 212	100	100	57	✓		
EM / ET 213	122	120	37	✓		
EM / ET 214	200	120	57		✓	✓
EM / ET 215	120	80	57	✓		
EM / ET 217	122	120	57	✓		
EM / ET 218	150	150	57		✓	✓
EM / ET 220	160	80	57	✓		
EM / ET 221	200	120	77	✓		
EM / ET 223	200	150	77	✓		
EM / ET 224	240	80	60		✓	✓
EM / ET 225	82	80	87	✓		
EM / ET 227	122	120	87	✓		
EM / ET 229	160	80	37	✓		
EM / ET 231	160	80	87	✓		
EM / ET 232	200	150	37	✓		
EM / ET 233	250	160	37	✓		
EM / ET 236	240	80	80		✓	✓
EM / ET 237	200	120	92	✓		
EM / ET 238	160	120	92	✓		
EM / ET 239	250	160	57	✓		
EM / ET 240	250	160	92	✓		
EM / ET 241	250	160	122	✓		
EM / ET 242	240	120	102	✓		
EM / ET 247	300	160	120		✓	✓

EM-F / ET-F-Versionen: Maß C ist durch den
Folientastaturrand am Deckel um 1 mm höher.

Zubehör



GummifüÙe



Schraubenabdeckungen



Tragschienen
TH 15, G 32, TH 35



Mastbefestigung

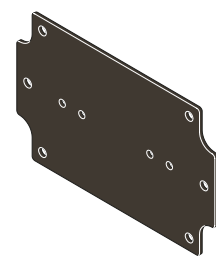

Montageplatten in diversen
Ausführungen

Euromas II

ABS, einfarbig



Gehäuse, ABS

Modell	Best.-Nr.	A	B	C	a1	a2	b1	b2	b3	c1	c2
ET 205	63205000	52	50	37	46.5	30	44.5	28	-	10	33
ET 206	63206000	65	50	37	59.5	43	44.5	28	-	10	32
ET 207 LP	63207300	82	60	57	75.3	56.5	53.3	25.5	-	15	51
ET 208	63208000	98	64	38	89.5	73.5	55.5	32.2	-	10	31.5
ET 210	63210000	82	80	57	75.3	56.5	73.3	36.5	-	15	51
ET 212	63212000	100	100	57	93.3	74.5	93.3	56.5	-	15	51
ET 213	63213000	122	120	37	115.6	96.8	113.6	76.8	-	15	31
ET 214 LP	63214300	200	120	57	193.2	174.4	113.2	74.3	-	15	51
ET 215	63215000	120	80	57	113.3	94.5	73.3	36.5	-	15	51
ET 217	63217000	122	120	57	115.3	96.5	113.3	76.5	-	15	51
ET 218 LP	63218300	150	150	57	143.3	124.5	143.3	106.5	-	15	51
ET 220	63220000	160	80	57	153.3	134.5	73.3	36.5	-	15	51
ET 221	63221000	200	120	77	192.9	174.1	112.9	74	-	15	71
ET 223	63223000	200	150	77	192.9	174.1	142.9	105.1	-	15	71
ET 224 LP	63224300	240	80	60	233.3	214.5	73.3	36.5	-	20	54
ET 225	63225000	82	80	87	75	56.2	73	36.2	-	15	81
ET 227	63227000	122	120	87	115	96.2	113	76.2	-	15	81
ET 229	63229000	160	80	37	153.6	134.8	73.6	36.8	-	15	31
ET 231	63231000	160	80	87	153	134.2	73	36.2	-	15	81
ET 232	63232000	200	150	37	193.6	174.8	143.6	105.8	-	15	31
ET 233	63233000	250	160	37	243.6	224.8	153.6	115.8	134.4	15	31
ET 236 LP	63236300	240	80	80	233.3	214.5	73.3	36.5	-	40	74
ET 237	63237000	200	120	92	192.9	174.1	112.9	74	-	30	86
ET 238	63238000	160	120	92	152.9	134.1	112.9	74	-	30	86
ET 239	63239000	250	160	57	243.4	224.6	153.4	115.6	134.5	15	51
ET 240	63240000	250	160	92	242.9	224.1	152.9	115.1	134.1	15	86
ET 241	63241000	250	160	122	242.9	224.1	152.9	115.1	134.1	45	116
ET 242	63242000	240	120	102	232.9	214.1	112.9	76.1	-	25	96
ET 247 LP	63247300	300	160	120	292.7	272.9	152.7	112.9	134.4	30	114

Lieferumfang: Ober- und Unterteil, selbstformende Steilgewinde-Deckelschrauben aus V2A

Hinweis: ABS-Gehäuse können aufgrund einer anderen Materialschwindung ca. 0,1 - 0,25 % größer sein.



BOPLA

A Phoenix Mecano Company

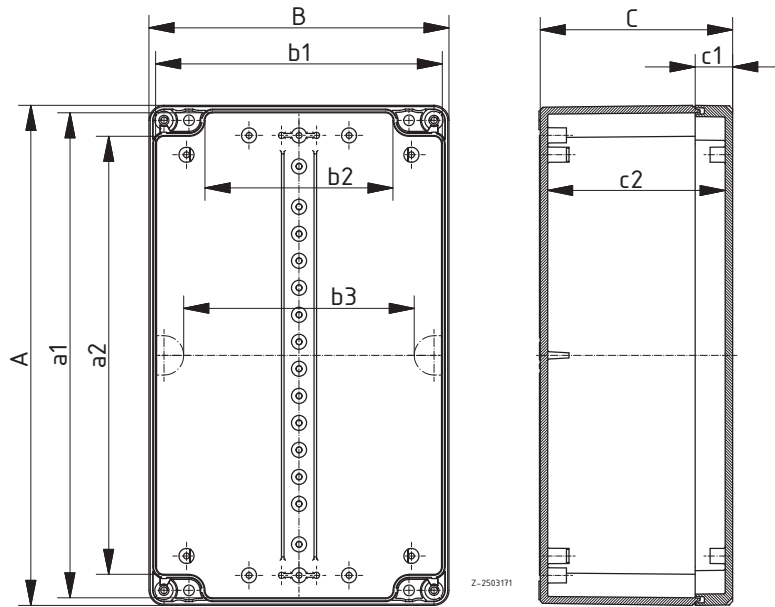

Euromas II

ABS, mit Folientastaturrand



Gehäuse, ABS

Modell	Best.-Nr.	A	B	C	a1	a2	b1	b2	b3	c1	c2
ET 205 F	63205200	52	50	37	46.5	30	44.5	28	-	10	33
ET 206 F	63206200	65	50	37	59.5	43	44.5	28	-	10	32
ET 207 F-LP	63207400	82	60	57	75.3	56.5	53.3	25.5	-	15	51
ET 208 F	63208200	98	64	38	89.5	73.5	55.5	32.2	-	10	31.5
ET 210 F	63210200	82	80	57	75.3	56.5	73.3	36.5	-	15	51
ET 212 F	63212200	100	100	57	93.3	74.5	93.3	56.5	-	15	51
ET 213 F	63213200	122	120	37	115.6	96.8	113.6	76.8	-	15	31
ET 214 F-LP	63214400	200	120	57	193.2	174.4	113.2	74.3	-	15	51
ET 215 F	63215200	120	80	57	113.3	94.5	73.3	36.5	-	15	51
ET 217 F	63217200	122	120	57	115.3	96.5	113.3	76.5	-	15	51
ET 218 F-LP	63218400	150	150	57	143.3	124.5	143.3	106.5	-	15	51
ET 220 F	63220200	160	80	57	153.3	134.5	73.3	36.5	-	15	51
ET 221 F	63221200	200	120	77	192.9	174.1	112.9	74	-	15	71
ET 223 F	63223200	200	150	77	192.9	174.1	142.9	105.1	-	15	71
ET 224 F-LP	63224400	240	80	60	233.3	214.5	73.3	36.5	-	20	54
ET 225 F	63225200	82	80	87	75	56.2	73	36.2	-	15	81
ET 227 F	63227200	122	120	87	115	96.2	113	76.2	-	15	81
ET 229 F	63229200	160	80	37	153.6	134.8	73.6	36.8	-	15	31
ET 231 F	63231200	160	80	87	153	134.2	73	36.2	-	15	81
ET 232 F	63232200	200	150	37	193.6	174.8	143.6	105.8	-	15	31
ET 233 F	63233200	250	160	37	243.6	224.8	153.6	115.8	134.4	15	31
ET 236 F-LP	63236400	240	80	80	233.3	214.5	73.3	36.5	-	40	74
ET 237 F	63237200	200	120	92	192.9	174.1	112.9	74	-	30	86
ET 238 F	63238200	160	120	92	152.9	134.1	112.9	74	-	30	86
ET 239 F	63239200	250	160	57	243.4	224.6	153.4	115.6	134.5	15	51
ET 240 F	63240200	250	160	92	242.9	224.1	152.9	115.1	134.1	15	86
ET 241 F	63241200	250	160	122	242.9	224.1	152.9	115.1	134.1	45	116
ET 242 F	63242200	240	120	102	232.9	214.1	112.9	76.1	-	25	96
ET 247 F-LP	63247400	300	160	120	292.7	272.9	152.7	112.9	134.4	30	114

Lieferumfang: Ober- und Unterteil, selbstformende Steilgewinde-Deckelschrauben aus V2A

Hinweis: ABS-Gehäuse können aufgrund einer anderen Materialschwindung ca. 0,1 - 0,25 % größer sein.



BOPLA

A Phoenix Mecano Company

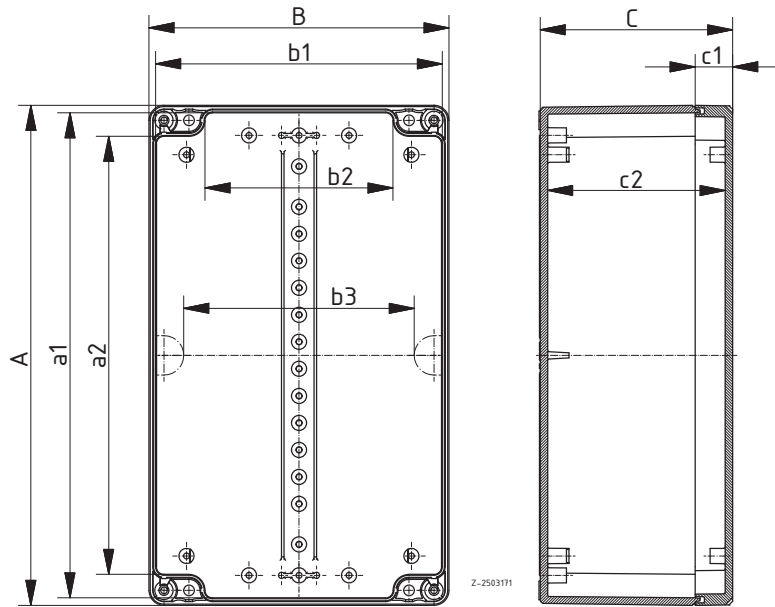

Euromas II

PC, einfarbig

Gehäuse, Polycarbonat



Modell	Best.-Nr.	A	B	C	a1	a2	b1	b2	b3	c1	c2
EM 205	62205000	52	50	37	46.5	30	44.5	28	-	10	33
EM 206	62206000	65	50	37	59.5	43	44.5	28	-	10	32
EM 207 LP	62207300	82	60	57	75.3	56.5	53.3	25.5	-	15	51
EM 208	62208000	98	64	38	89.5	73.5	55.5	32.2	-	10	31.5
EM 210	62210000	82	80	57	75.3	56.5	73.3	36.5	-	15	51
EM 212	62212000	100	100	57	93.3	74.5	93.3	56.5	-	15	51
EM 213	62213000*	122	120	37	115.6	96.8	113.6	76.8	-	15	31
EM 214 LP	62214300	200	120	57	193.2	174.4	113.2	74.3	-	15	51
EM 215	62215000	120	80	57	113.3	94.5	73.3	36.5	-	15	51
EM 217	62217000	122	120	57	115.3	96.5	113.3	76.5	-	15	51
EM 218 LP	62218300	150	150	57	143.3	124.5	143.3	106.5	-	15	51
EM 220	62220000	160	80	57	153.3	134.5	73.3	36.5	-	15	51
EM 221	62221000	200	120	77	192.9	174.1	112.9	74	-	15	71
EM 223	62223000	200	150	77	192.9	174.1	142.9	105.1	-	15	71
EM 224 LP	62224300	240	80	60	233.3	214.5	73.3	36.5	-	20	54
EM 225	62225000	82	80	87	75	56.2	73	36.2	-	15	81
EM 227	62227000	122	120	87	115	96.2	113	76.2	-	15	81
EM 229	62229000*	160	80	37	153.6	134.8	73.6	36.8	-	15	31
EM 231	62231000	160	80	87	153	134.2	73	36.2	-	15	81
EM 232	62232000*	200	150	37	193.6	174.8	143.6	105.8	-	15	31
EM 233	62233000*	250	160	37	243.6	224.8	153.6	115.8	134.4	15	31
EM 236 LP	62236300	240	80	80	233.3	214.5	73.3	36.5	-	40	74
EM 237	62237000	200	120	92	192.9	174.1	112.9	74	-	30	86
EM 238	62238000	160	120	92	152.9	134.1	112.9	74	-	30	86
EM 239	62239000	250	160	57	243.4	224.6	153.4	115.6	134.5	15	51
EM 240	62240000	250	160	92	242.9	224.1	152.9	115.1	134.1	15	86
EM 241	62241000	250	160	122	242.9	224.1	152.9	115.1	134.1	45	116
EM 242	62242000	240	120	102	232.9	214.1	112.9	76.1	-	25	96
EM 247 LP	62247300	300	160	120	292.7	272.9	152.7	112.9	134.4	30	114

Lieferumfang: Ober- und Unterteil, selbstformende Steilgewinde-Deckelschrauben aus V2A

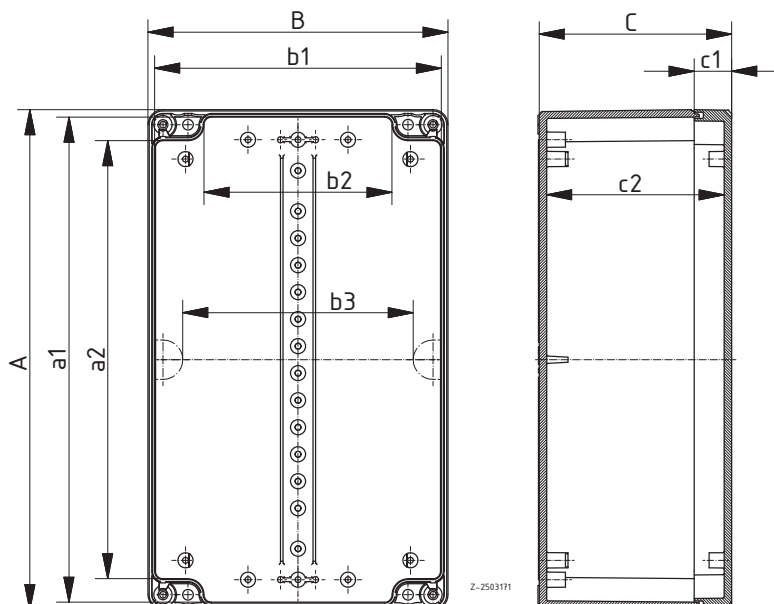

Euromas II

PC, mit Folientastaturrand

Gehäuse, Polycarbonat

Modell	Best.-Nr.	A	B	C	a1	a2	b1	b2	b3	c1	c2
EM 205 F	62205200	52	50	37	46.5	30	44.5	28	-	10	33
EM 206 F	62206200	65	50	37	59.5	43	44.5	28	-	10	32
EM 207 F-LP	62207400	82	60	57	75.3	56.5	53.3	25.5	-	15	51
EM 208 F	62208200	98	64	38	89.5	73.5	55.5	32.2	-	10	31.5
EM 210 F	62210200	82	80	57	75.3	56.5	73.3	36.5	-	15	51
EM 212 F	62212200	100	100	57	93.3	74.5	93.3	56.5	-	15	51
EM 213 F	62213200*	122	120	37	115.6	96.8	113.6	76.8	-	15	31
EM 214 F-LP	62214400	200	120	57	193.2	174.4	113.2	74.3	-	15	51
EM 215 F	62215200	120	80	57	113.3	94.5	73.3	36.5	-	15	51
EM 217 F	62217200	122	120	57	115.3	96.5	113.3	76.5	-	15	51
EM 218 F-LP	62218400	150	150	57	143.3	124.5	143.3	106.5	-	15	51
EM 220 F	62220200	160	80	57	153.3	134.5	73.3	36.5	-	15	51
EM 221 F	62221200	200	120	77	192.9	174.1	112.9	74	-	15	71
EM 223 F	62223200	200	150	77	192.9	174.1	142.9	105.1	-	15	71
EM 224 F-LP	62224400	240	80	60	233.3	214.5	73.3	36.5	-	20	54
EM 225 F	62225200	82	80	87	75	56.2	73	36.2	-	15	81
EM 227 F	62227200	122	120	87	115	96.2	113	76.2	-	15	81
EM 229 F	62229200*	160	80	37	153.6	134.8	73.6	36.8	-	15	31
EM 231 F	62231200	160	80	87	153	134.2	73	36.2	-	15	81
EM 232 F	62232200*	200	150	37	193.6	174.8	143.6	105.8	-	15	31
EM 233 F	62233200*	250	160	37	243.6	224.8	153.6	115.8	134.4	15	31
EM 236 F-LP	62236400	240	80	80	233.3	214.5	73.3	36.5	-	40	74
EM 237 F	62237200	200	120	92	192.9	174.1	112.9	74	-	30	86
EM 238 F	62238200	160	120	92	152.9	134.1	112.9	74	-	30	86
EM 239 F	62239200	250	160	57	243.4	224.6	153.4	115.6	134.5	15	51
EM 240 F	62240200	250	160	92	242.9	224.1	152.9	115.1	134.1	15	86
EM 241 F	62241200	250	160	122	242.9	224.1	152.9	115.1	134.1	45	116
EM 242 F	62242200	240	120	102	232.9	214.1	112.9	76.1	-	25	96
EM 247 F-LP	62247400	300	160	120	292.7	272.9	152.7	112.9	134.4	30	114



Lieferumfang: Ober- und Unterteil, selbstformende Steilgewinde-Deckelschrauben aus V2A

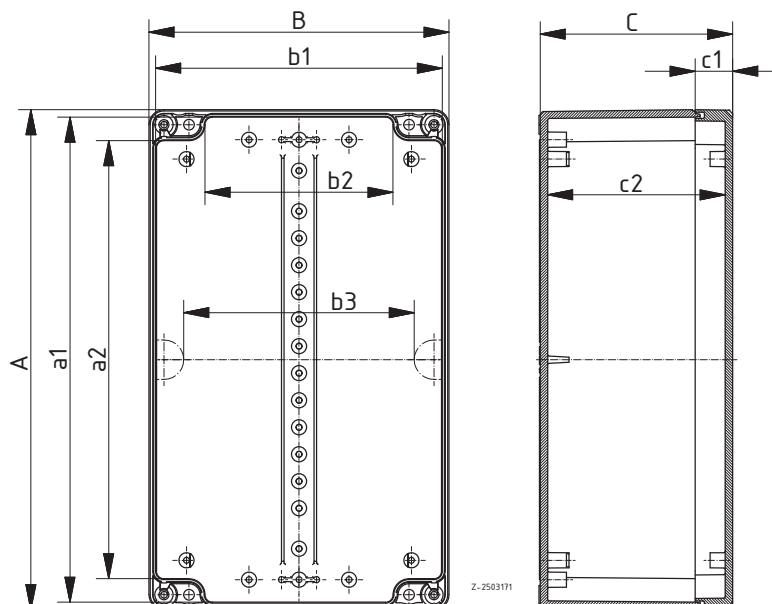

Zubehör siehe Ende des Kapitels.

Euromas II

Montageplatten



Montageplatten, Hartpapier

Modell	Best.-Nr.	Hinweis
M	22000100	Für EM/ET 205, M/T 205
M	22000200	Für EM/ET 206, M/T 206
M	22207001	Für EM/ET 207**
M	22000300	Für EM/ET 210, EM/ET 225, M/T 210, M/T 225
M	22000400	Für EM/ET 215, M/T 215-216, M/T 226, M/T 230
M	22212000	Für EM/ET 212**
M	22000500	Für EM/ET 217, EM/ET 227, M/T 217, M/T 227-228
M	22214001	Für EM/ET 214**
M	22000600	Für EM/ET 220, EM/ET 231, M/T 219-220, M/T 231-235
M	22000700	Für EM/ET 221, EM/ET 237, M/T 221, M/T 237
M	22000800	Für EM/ET 223, M/T 223
M	22218001	Für EM/ET 218**
M	22000900	Für EM/ET 239-241, M/T 240, M/T 241, M/T 250
M	22001100	Für EM/ET 238, M/T 238, M/T 2381, M/T 246
M	22001200	Für EM/ET 242, M/T 242
M	22224001	Für EM/ET 224, EM/ET 236**
M	22247001	Für EM/ET 247**

Lieferumfang: 1 Montageplatte

Hinweis: ** = Die Montageplatte ist auch im Gehäusedeckel montierbar.

Euromas II

Zubehör

Mastbefestigung, Edelstahl V2A, unbeschichtet

Modell	Best.-Nr.
MH 080	96500080
MH 122	96500122
MH 167	96500167
MH 220	96500220
MH 265	96500265

Lieferumfang: MH: 1 Satz (2 Stück) BFS: 20 Stück

Hinweis: Befestigungssatz bitte gemäß Tabelle (siehe "Produktinformationen") separat bestellen.



Befestigungssatz für Mastbefestigung

Modell	Best.-Nr.	Hinweis
BFS MH 1	96500001	Befestigungssatz
BFS MH 2	96500002	Befestigungssatz
BFS MH 3	96500003	Befestigungssatz

Lieferumfang: 20 Stück (für 5 Satz Mastbefestigungen)

Hinweis: Die passende Mastbefestigung je Gehäusegröße sowie den dazugehörigen Befestigungssatz bitte aus der Tabelle (siehe „Produktinformationen“) entnehmen.



Schelle für Mastbefestigung, Edelstahl

Modell	Best.-Nr.	Hinweis
MH S 32-50	96500050	Klemmbereich 32-50 mm
MH S 50-70	96500070	Klemmbereich 50-70 mm
MH S 70-90	96500090	Klemmbereich 70-90 mm
MH S 90-110	96500110	Klemmbereich 90-110 mm
MH S 110-130	96500130	Klemmbereich 110-130 mm
MH S 130-150	96500150	Klemmbereich 130-150 mm
MH S 150-170	96500175	Klemmbereich 150-170 mm
MH S 170-190	96500190	Klemmbereich 170-190 mm
MH S 190-210	96500210	Klemmbereich 190-210 mm

Lieferumfang: 10 Stück



Verwendung der Mastbefestigung für Euromas II
Use of the mast mounting for Euromas II

Bitte wählen Sie anhand dieser Tabelle je nach Größe und Ausrichtung des Gehäuses die passende Mastbefestigung und den dazugehörigen Befestigungssatz aus.

Please use this table to select the appropriate mast mounting and the associated mounting kit, depending on the size and alignment of the enclosure.

Ausrichtung des Gehäuses / Alignment of the enclosure :

H = horizontal V = vertical

Gehäuse Enclosure	Mastbefestigung Mast mounting		Befestigungssatz Mounting kit
EM/ET 210 H	= MH 080	+	BFS MH 1
EM/ET 210 V	= MH 080	+	BFS MH 1
EM/ET 212 H	= MH 122	+	BFS MH 1
EM/ET 212 V	= MH 080	+	BFS MH 1
EM/ET 213 V/H	= MH 122	+	BFS MH 1
EM/ET 214-LP H	= MH 220	+	BFS MH 1
EM/ET 214-LP V	= MH 122	+	BFS MH 1
EM/ET 215 H	= MH 122	+	BFS MH 1
EM/ET 215 V	= MH 080	+	BFS MH 1
EM/ET 217 V/H	= MH 122	+	BFS MH 1
EM/ET 218-LP H	= MH 167	+	BFS MH 1
EM/ET 218-LP V	= MH 167	+	BFS MH 1
EM/ET 220 H	= MH 167	+	BFS MH 1
EM/ET 220 V	= MH 080	+	BFS MH 1
EM/ET 221 H	= MH 220	+	BFS MH 1
EM/ET 221 V	= MH 122	+	BFS MH 1
EM/ET 223 H	= MH 220	+	BFS MH 1
EM/ET 223 V	= MH 167	+	BFS MH 1
EM/ET 224 H	= MH 265	+	BFS MH 1
EM/ET 224 V	= MH 080	+	BFS MH 1
EM/ET 225 H	= MH 080	+	BFS MH 1
EM/ET 225 V	= MH 080	+	BFS MH 1
EM/ET 227 V	= MH 122	+	BFS MH 1
EM/ET 229 H	= MH 167	+	BFS MH 1
EM/ET 229 V	= MH 080	+	BFS MH 1
EM/ET 231 H	= MH 167	+	BFS MH 1
EM/ET 231 V	= MH 080	+	BFS MH 1
EM/ET 232 H	= MH 220	+	BFS MH 1
EM/ET 232 V	= MH 167	+	BFS MH 1
EM/ET 233 V	= MH 167	+	BFS MH 1
EM/ET 236-LP H	= MH 265	+	BFS MH 1
EM/ET 236-LP V	= MH 080	+	BFS MH 1
EM/ET 237 H	= MH 220	+	BFS MH 1
EM/ET 237 V	= MH 122	+	BFS MH 1
EM/ET 238 H	= MH 167	+	BFS MH 1
EM/ET 238 V	= MH 122	+	BFS MH 1
EM/ET 239 H	= MH 265	+	BFS MH 1
EM/ET 239 V	= MH 167	+	BFS MH 1
EM/ET 240 H	= MH 265	+	BFS MH 1
EM/ET 240 V	= MH 167	+	BFS MH 1
EM/ET 241 H	= MH 265	+	BFS MH 1
EM/ET 241 V	= MH 167	+	BFS MH 1
EM/ET 242 H	= MH 265	+	BFS MH 1
EM/ET 242 V	= MH 122	+	BFS MH 1
EM/ET 247 V	= MH 167	+	BFS MH 1

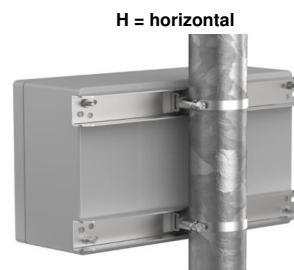

Stand 23.03.2021

Euromas II

Zubehör

Wandlaschen rückseitig anschraubbar

Modell	Best.-Nr.
EM-WL	22010000

Lieferumfang: 4 Wandlaschen (Polycarbonat), Schrauben



GummifüÙe, selbstklebend

Modell	Best.-Nr.	Farbton	Hinweis
GF	22009000	Schwarz	Polyurethan, 65-75 Shore

Lieferumfang: 4 Stück



Schraubenabdeckungen

Modell	Best.-Nr.
EM-SA	22080000

Lieferumfang: 6 Schraubenabdeckungen (Polycarbonat)



Tragschiene nach DIN EN 60715 TH 15

Modell	Best.-Nr.	Hinweis
TS 15	22150501	Für EM/ET 206
TS 15	22150701	Für EM/ET 207-210, EM/ET 225, B 1008..
TS 15	22150901	Für EM/ET 212
TS 15	22151101	Für EM/ET 213, EM/ET 215-217, EM/ET 227, B 1408.., B 1413..
TS 15	22151901	Für EM/ET 214, EM/ET 221-223, EM/ET 232, EM/ET 237, BCD 200, B 2213..
TS 15	22151401	Für EM/ET 218
TS 15	22151501	Für EM/ET 220, EM/ET 229-231, EM/ET 238, B 1808.., B 1813..
TS 15	22152301	Für EM/ET 224, EM/ET 233-236, EM/ET 239-242, B 2617.., B 2613.., B 2736.. (Quer)
TS 15	22152901	Für EM/ET 247

Lieferumfang: 1 Tragschiene



Euromas II

Zubehör



Tragschiene nach DIN EN 60715 G 32

Modell	Best.-Nr.	Hinweis
TS 32	22320701	Für EM/ET 208-210, EM/ET 225, B 1008..
TS 32	22320901	Für EM/ET 212
TS 32	22321101	Für EM/ET 213, EM/ET 215-217, EM/ET 227, B 1408.., B 1413..
TS 32	22321901	Für EM/ET 214, EM/ET 221-223, EM/ET 232, EM/ET 237, B 22130.
TS 32	22321401	Für EM/ET 218
TS 32	22321501	Für EM/ET 220, EM/ET 229-231, EM/ET 238, B 1808.., B 1813..
TS 32	22322301	Für EM/ET 224, EM/ET 233-236, EM/ET 239-242, B 2617.., B 2613.., B 2736.. (Quer)
TS 32	22322901	Für EM/ET 247

Lieferumfang: 1 Tragschiene



Tragschiene nach DIN EN 60715 TH 35

Modell	Best.-Nr.	Hinweis
TS 35	22350701	Für EM/ET 208-210, EM/ET 225, B 1008..
TS 35	22350901	Für EM/ET 212
TS 35	22351101	Für EM/ET 213, EM/ET 215-217, EM/ET 227, B 1408.., B 1413..
TS 35	22351901	Für EM/ET 214, EM/ET 221-223, EM/ET 232, EM/ET 237, BCD 200, B 2213..
TS 35	22351401	Für EM/ET 218
TS 35	22351501	Für EM/ET 220, EM/ET 229-231, EM/ET 238, B 1808.., B 1813..
TS 35	22352301	Für EM/ET 224, EM/ET 233-236, EM/ET 239-242, B 2617.., B 2613.., B 2736.. (Quer)
TS 35	22352901	Für EM/ET 247

Lieferumfang: 1 Tragschiene



BOPLA

A Phoenix Mecano Company