

# SNACOMPACT

TERMINAL BLOCKS - SCREW CLAMP TECHNOLOGY

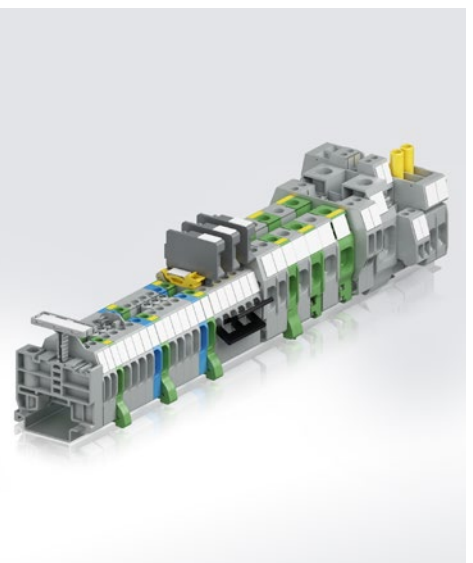

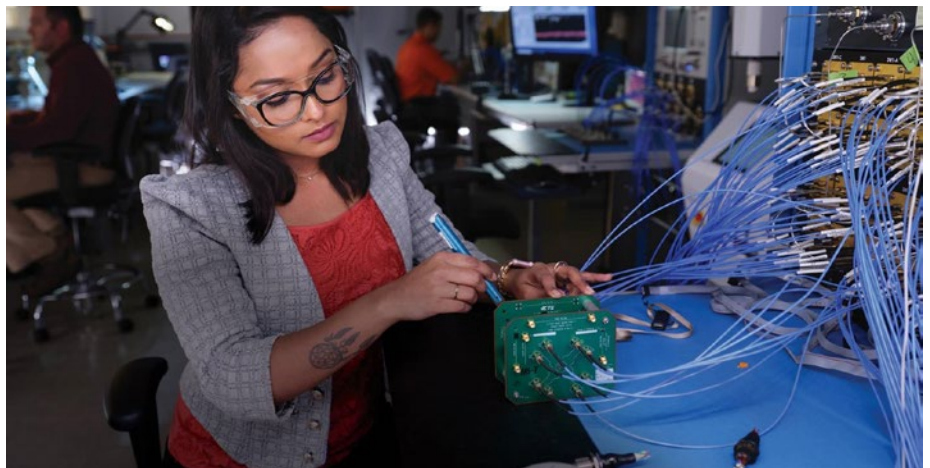

## **General contents**

### **SNACompact terminal blocks Screw clamp technology**

Features & Benefits .....	p. 3
Selection guide .....	p. 6
SNACompact Terminal blocks offering .....	p. 8
Accessories.....	p. 68
Marking system & accessories.....	p. 79
CrossReference table .....	p. 86
Index .....	p. 87





# SNACompact Terminal blocks

Features & Benefits

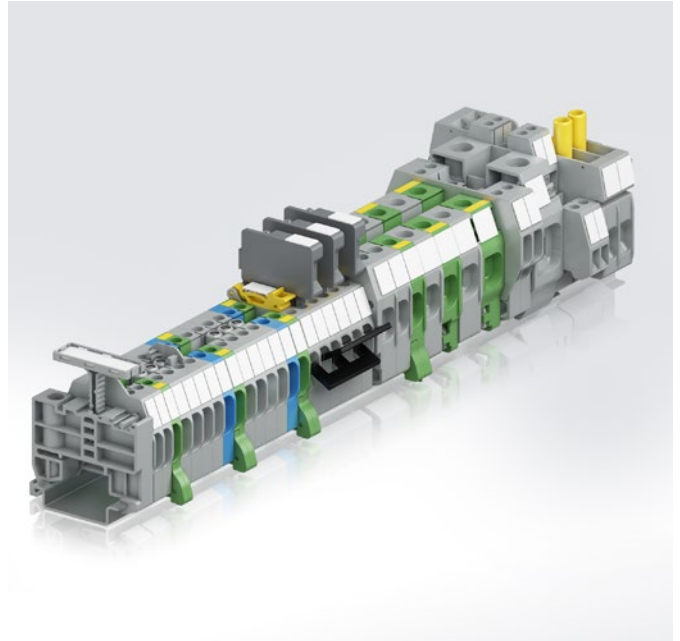

## SNACOMPACT SMALL IS BIG!

SMALL IS BIG WITH SNACOMPACT TERMINAL BLOCKS THAT HELP TO IMPROVE PANEL BUILDING PROCESS PROVIDING COMPACT AND PERFORMANT PRODUCTS RELYING ON MORE THAN 60 YEARS OF TRACK-RECORD

### Benefit from high performances in smaller space

- **Secure your wiring with ENTRELEC screw clamp** featuring hardened steel, anti-release system, funnel entry for conductor, tab under clamp
- **Save up to 14% in height** for 2.5 and 4 mm<sup>2</sup> versus SNA-type terminal blocks, which allows to fit in smaller junction boxes
- **Provide for a long lifetime** on site time-tested by 60 years track record on screw technology, fire resistant VO plastic grade and installation in harsh environments.

### Improve your panel building process

- **Optimize the installation, wiring and connection**, by taking benefit from ENTRELEC design, screwless ground connection, well aligned fuse and disconnect version
- **Reduces mounting errors** thanks to asymmetrical design and by using compatible TE Connectivity's end ferrules and crimping tools
- **Improve the layout & identification of the panel** by using TE Connectivity's large cable management portfolio, including identification labels, card and roll printing systems, cable ties and cable wrapping accessories
- **Save time when designing your panel** thanks to TE Connectivity's digital tools, such as TE.COM and Easy Rail Designer 3D CAD software allowing complete rail assembly design and 3D viewing functionality.

# IMPROVE YOUR PANEL BUILDING PROCESS WITH SNACOMPACT

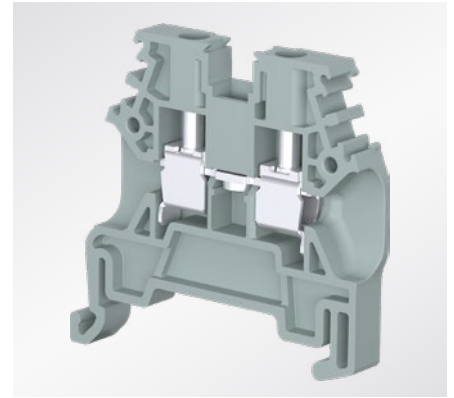

## BENEFIT FROM HIGH PERFORMANCES IN SMALLER SPACE

**Secure your wiring with ENTRELEC screw clamp** featuring hardened steel, anti-release system, funnel entry for conductor, tab under clamp.

The SNACompact screw clamp is designed to reduce accidental releases due to vibrations, shocks or even abusive cable draw and can fit up to two conductors per clamp which offers extended possibilities in electrical cabinets.

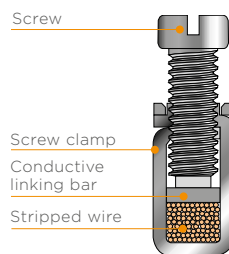

The TE Connectivity anti-release system creates a controlled locking-screw effect thanks to the 2 overlapping tabs that maintain the clamp parts. The screw is locked with safety. The retightening campaigns are not needed anymore!

The screw tightens the conductive bar to the cable. There is no torsion effect applied to the cable

The clamp is punched, which increases the number of screw threads by 30 % meaning a high torque resistance

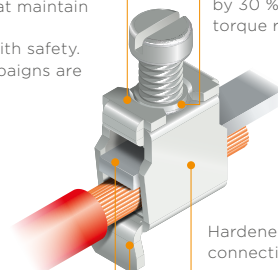

Hardened steel makes the connection very reliable

Flap avoiding the insertion of cable underneath the clamp

**Save up to 14% in height** for 2.5 and 4 mm<sup>2</sup> versus legacy terminal blocks, which allows to fit in smaller junction boxes.

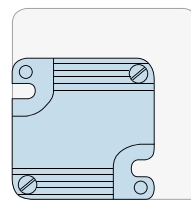
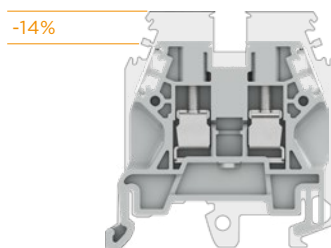

Reduced size junction box with SNACompact

**Provide for a long lifetime** on site proven by 60 years track record on screw technology, fire resistant V0 plastic grade and installation in harsh environments. SNACompact terminal blocks have been tested upon many environmental tests:

- Vibrations: IEC 60068-2-6 standard
- Corrosion: salt mist as per IEC 60068-2 §11
- Flammability: UL94V0 & needle burning test (IEC 60947-7-1 §8.4.6)
- Short-circuit: IEC 60947-7-1 §8.4.6.

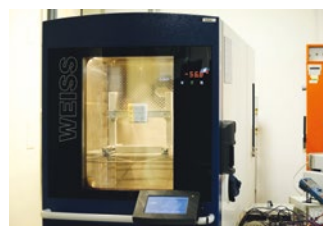

# SNACompact Terminal blocks

## Features & Benefits

### IMPROVE YOUR PANEL BUILDING PROCESS

**Optimize the installation, wiring and connection**, by taking benefit from Entelec design, screwless ground connection, aligned fuse and disconnect version.

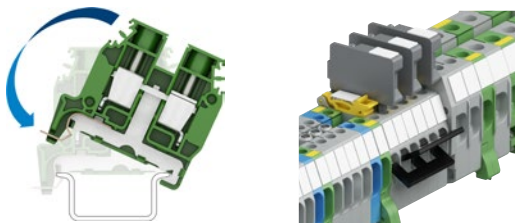

**Reduces mounting errors** thanks to asymmetrical design and by using compatible TE Connectivity's end ferrules and crimping tools.

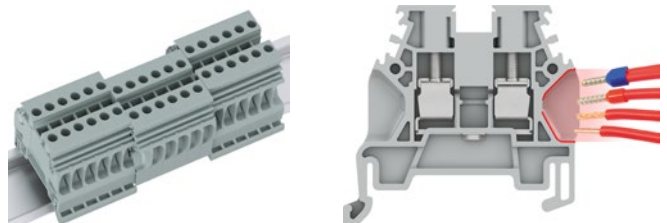

**Improve the layout & identification of the panel** by using TE Connectivity's large cable management portfolio, including identification labels, card and roll printing systems, cable ties and cable wrapping accessories.

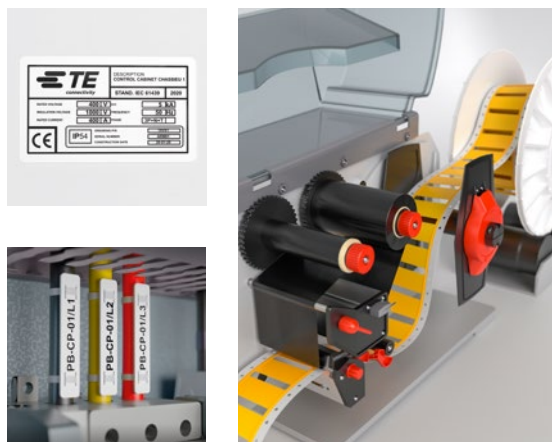



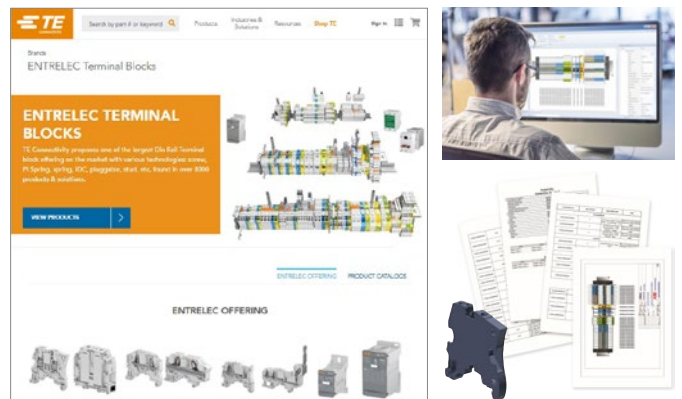







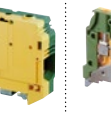
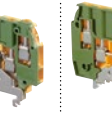

**Save time when designing your panel** thanks to TE Connectivity's digital tools, such as TE.COM providing in few clicks the technical datasheets, cross-references, accessory compatibility, 2D/3D models and fast sample ordering possibility, and Easy Rail Designer 3D CAD software allowing rail assembly design and 3D viewing functionality.

















# SNACompact Terminal blocks

## Selection guide





Section		Feed-through			Ground			
								
IEC	UL/CSA							
2.5 mm <sup>2</sup>	12 AWG	C2.5/5			C2.5/5.P			
	10 AWG	C2.5/6			C2.5/6.P			
4 mm <sup>2</sup>	10 AWG	C2.5/6* ; C4/6	M4/6.3A	M4/6.4A	C4/6.P	M4/6.3A.P	M4/6.4A.P	
6 mm <sup>2</sup>	8 AWG	C6/8			C6/8.P			
10 mm <sup>2</sup>	6 AWG	C10/10			C10/10.P			
16 mm <sup>2</sup>	4 AWG	C16/12			M16/12.P			
35 mm <sup>2</sup>	0 AWG	M35/16			M35/16.P			
70 mm <sup>2</sup>	00 AWG	D70/22			D70/22.P			
95 mm <sup>2</sup>	0000 AWG	D95/26			D95/26.P			





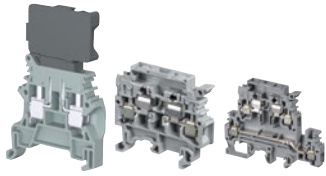
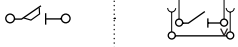

\*: manufacturer wiring data

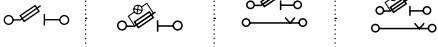
Section		Double deck				Triple deck		
								
IEC	UL/CSA							
2.5 mm <sup>2</sup>	12 AWG	MA2.5/5.D2	MA2.5/5.D1					
	10 AWG							
4 mm <sup>2</sup>	12 AWG	M4/6.D2	M4/6.D1	M4/6.DD	M4/6.DD1	D4/6.T3	D4/6.T1	D4/6.T3.P
6 mm <sup>2</sup>	8 AWG	M6/8.D2	M6/8.D1					

# SNACompact Terminal blocks

## Selection guide

		Disconnect with blade		Test and Measurement Disconnect with sliding link		For 5 x 20 mm fuses			
Section									
									
IEC	UL/CSA								
2.5 mm <sup>2</sup>	12 AWG	MA2.5/5.SNB							
4 mm <sup>2</sup>	12 AWG	C4/6.S	M4/6.D2.SNBT			C4/8.SF	M4/8.SFD	M4/8.D2.SF	M4/8.D2.SFD3
							M4/8.SFD3		M4/8.D2.SFL
	10 AWG	M4/6.SNB				C4/6.SF	C4/6.SFD24		
						C4/6.SFD250			
6 mm <sup>2</sup>	8 AWG	M6/8.SNB		M6/8.ST1	C6/8.ST1.IP20				
				C6/8.ST1					

		Sensor/actuator		Thermocouple	Miniblocks			
Section								
								
IEC	UL/CSA			MTC6				
0.9 to 1.5mm Dia.					DR1.5/4	DR1.5/5		
1.5 mm <sup>2</sup>								
2.5 mm <sup>2</sup>		D2.5/6.D	D2.5/6.DL					
4 mm <sup>2</sup>	12 AWG					DR4/6	DR4/6.P	
	10 AWG							

## SNACompact range

Terminal blocks Screw clamp technology

---



## Offer Contents

### Feed-through

2,5 mm <sup>2</sup> /12 AWG	C2.5/5.....	p. 10
2,5 mm <sup>2</sup> /10 AWG	C2.5/6.....	p. 11
4 mm <sup>2</sup> /10 AWG	C4/6 .....	p. 12
	M4/6.3A.....	p. 13
	M4/6.4A.....	p. 14
6 mm <sup>2</sup> /8 AWG	C6/8 .....	p. 15
10 mm <sup>2</sup> /6 AWG	C10/10 .....	p. 16
16 mm <sup>2</sup> /4 AWG	C16/12 .....	p. 17
35 mm <sup>2</sup> /0 AWG	M35/16.....	p. 18
70 mm <sup>2</sup> /00 AWG	D70/22 .....	p. 19
95 mm <sup>2</sup> /0000 AWG	D95/26 .....	p. 20

### Ground

2,5 mm <sup>2</sup> /12 AWG	C2.5/5.P .....	p. 21
2,5 mm <sup>2</sup> /10 AWG	C2.5/6.P.....	p. 22
4 mm <sup>2</sup> /10 AWG	C4/6.P.....	p. 23
	M4/6.3A.P.....	p. 24
	M4/6.4A.P.....	p. 25
6 mm <sup>2</sup> /8 AWG	C6/8.P.....	p. 26
10 mm <sup>2</sup> /6 AWG	C10/10.P.....	p. 27
16 mm <sup>2</sup> /4 AWG	M16/12.P.....	p. 28
35 mm <sup>2</sup> /0 AWG	M35/16.P.....	p. 29
70 mm <sup>2</sup> /00 AWG	D70/22 .....	p. 30
95 mm <sup>2</sup> /0000 AWG	D95/26.P.....	p. 31

### Double deck

2,5 mm <sup>2</sup> /12 AWG	MA2.5/5.D2 .....	p. 32
	MA2.5/5.D1.1 .....	p. 33
4 mm <sup>2</sup> /12 AWG	M4/6.D2.....	p. 34
4 mm <sup>2</sup> /10 AWG	M4/6.D1.....	p. 35
4 mm <sup>2</sup> /12 AWG	M4/6.DD.....	p. 36
	M4/6.DD1.....	p. 37
6 mm <sup>2</sup> /8 AWG	M6/8.D2.....	p. 38
	M6/8.D1.....	p. 39

### Triple deck

4 mm <sup>2</sup> /12 AWG	D4/6.T3 .....	p. 40
	D4/6.T1 .....	p. 41

### Disconnect with blade

2,5 mm <sup>2</sup> /12 AWG	MA2.5/5.SNB.....	p. 42
4 mm <sup>2</sup> /10 AWG	C4/6.S.....	p. 43
	M4/6.SNB.....	p. 44
6 mm <sup>2</sup> /8 AWG	M6/8.SNB.....	p. 45
4 mm <sup>2</sup> /12 AWG	M4/6.D2.SNBT .....	p. 46

### Test and Measurement

Typical schematics for measuring devices.		p. 48
6 mm <sup>2</sup> /8 AWG	C6/8.ST1.....	p. 49
	C6/8.ST1.IP20 .....	p. 50
	M6/8.ST1 .....	p. 51

### For 5 x 20 mm fuses

4 mm <sup>2</sup> /10 AWG	C4/6.SF .....	p. 53
	C4/6.SFD .....	p. 54
4 mm <sup>2</sup> /12 AWG	C4/8.SF.....	p. 55
	M4/8.SFD3 .....	p. 56
	M4/8.SF .....	p. 57
	M4/8.D2.SF.....	p. 58

### Thermocouple

MTC6.....	p. 60
-----------	-------

### Sensor/Actuator

D2.5/6.D.....	p. 61
D2.5/6.DL.....	p. 62

### Marshalling cabinets application.

	p. 63
--	-------

### Miniblocks

1.5 mm <sup>2</sup>	DR1.5/4.....	p. 64
1.5 mm <sup>2</sup> /12 AWG	DR1.5/5.....	p. 65
4 mm <sup>2</sup> /12 AWG	DR4/6 .....	p. 66
	DR4/6.P .....	p. 67

## C2.5/5 screw clamp terminal blocks

Feed-through - 5 mm 0.2 in spacing



2.5 mm<sup>2</sup>  
12 AWG

### Description

- 2.5 mm<sup>2</sup> feed-through terminal with TE screw clamp connection,
- Save space by connecting conductors up to 4 mm<sup>2</sup> in just 5 mm 0.197 in spacing.

### Ordering details

Description	Color	Type	Part Numbers	Pkg qty	Weight (1 pce) g
Feed-through 2 connections	Grey <input type="checkbox"/>	C2.5/5	1SNL605010R0000	100	5.5
	Blue <input type="checkbox"/>	C2.5/5.N	1SNL605020R0000	100	5.5

### Main technical data

Connecting capacity		IEC	UL - CSA	Mounting instructions	
1 conductor per clamp	Rigid - Solid / Stranded	0.2 ... 4 mm <sup>2</sup>	24 ... 12 AWG	Rail	TH 35-7.5, TH 35-15
	Flexible with non insulated ferrule	0.2 ... 2.5 mm <sup>2</sup>	24 ... 12 AWG	Wire stripping length	10 mm 0.39 in
	with insulated ferrule	0.2 ... 4 mm <sup>2</sup>	24 ... 12 AWG		
	Gauge	0.2 ... 2.5 mm <sup>2</sup>	24 ... 14 AWG		
2 conductors per clamp	Rigid - Solid / Stranded	0.2 ... 1.5 mm <sup>2</sup>	24 ... 16 AWG	Tool	Flat screwdriver Ø 3.5 mm Ø 0.14 in
	Flexible with twin ferrule	0.2 ... 1.5 mm <sup>2</sup>	24 ... 18 AWG		
	Rated current / Rated cross section	24 A / 2.5 mm <sup>2</sup>	20 A / 12 AWG	Torque	0.5 N.m ± 0.1 4.4 lb.in ± 0.9
Rated short-time withstand current (1s)	300 A				
Short Circuit Current Rating (with specific conditions)					
Rated voltage	1000 V	600 V			
Impulse withstand voltage	8000 V				
Protection	IP20	NEMA 1			

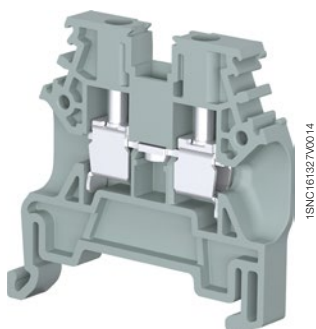

1SNC1613270014

C2.5/5

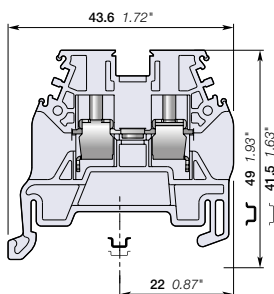

5 mm 0.2 in spacing

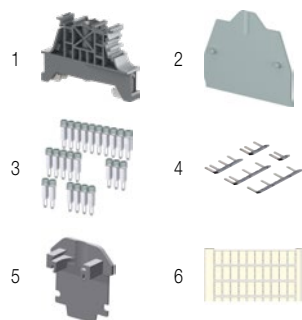

### Accessories

Description	Color	Type	Part Numbers	Pkg qty	Weight (1 pce) g	
1 End stops	Grey <input type="checkbox"/>	BAM4	1SNK900001R0000	50	12.00	
		BAZ1	1SNK900002R0000	50	4.70	
2 End sections	Grey <input type="checkbox"/>	EP5-6	1SNL900100R0000	20	1.6	
3 Jumper bars	Grey <input type="checkbox"/>	2 poles	BJC15-2	1SNL905602R0000	10	3.95
		3 poles	BJC15-3	1SNL905603R0000	10	5.9
		4 poles	BJC15-4	1SNL905604R0000	10	7.9
		5 poles	BJC15-5	1SNL905605R0000	10	9.87
		10 poles	BJC15-10	1SNL905610R0000	10	19.7
		4 Lateral jumper bars	Grey <input type="checkbox"/>	PC5-2	1SNA113542R1000	10
		PC5-10	1SNA113544R1200	10	6.00	
5 Circuit separators	Grey <input type="checkbox"/>	CS5-6	1SNL900101R0000	10	1.16	
6 Terminal block markers	White <input type="checkbox"/>	RC510TT	1SNA231600R1500	22	12.00	
		RC510	1SNA231000R0700	10	5.20	

Complete list of accessories is indicated in the terminal block datasheet including end stops. Some accessories such as jumper bars may modify the terminal block's ratings: Complete information available in the accessories section of the catalog.

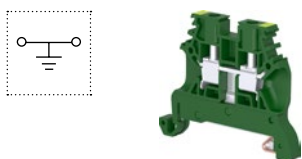

### Ground screw clamp terminal blocks

Description	Color	Type	Part Numbers	Pkg qty	Weight (1 pce) g
Ground	Green-yellow <input type="checkbox"/>	C2.5/5.P	1SNL605150R0000	100	8.5

Technical data valid for copper conductors only.



# C2.5/6 screw clamp terminal blocks

Feed-through - 6 mm 0.24 in spacing

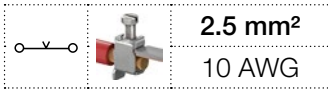

## Description

– 2.5 mm<sup>2</sup> feed-through terminal with TE screw clamp connection

## Ordering details

Description	Color	Type	Part Numbers	Pkg qty	Weight (1 pce) g
Feed-through 2 connections	Grey <input type="checkbox"/>	C2.5/6	1SNL606011R0000	100	6.4
	Blue <input type="checkbox"/>	C2.5/6.N	1SNL606021R0000	100	6.4

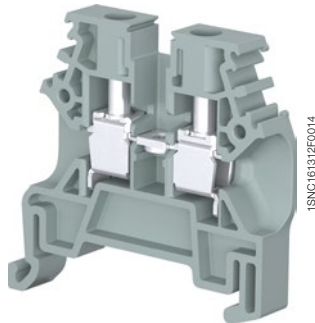

C2.5/6

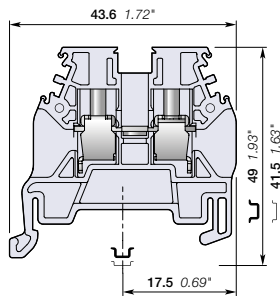

6 mm 0.24 in spacing

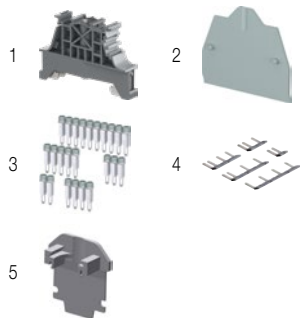

## Main technical data

Connecting capacity		IEC	UL - CSA	Mounting instructions
1 conductor per clamp	Rigid - Solid / Stranded	0.2 ... 4 mm <sup>2</sup>	24 ... 10 AWG	Rail  TH 35-7.5, TH 35-15
	Flexible	0.2 ... 4 mm <sup>2</sup>	24 ... 10 AWG	
	with non insulated ferrule	0.2 ... 4 mm <sup>2</sup>	24 ... 10 AWG	Wire stripping length  10 mm 0.39 in
	with insulated ferrule	0.2 ... 2.5 mm <sup>2</sup>	24 ... 12 AWG	
Gauge		A3		
2 conductors per clamp	Rigid - Solid / Stranded	0.2 ... 1.5 mm <sup>2</sup>	24 ... 14 AWG	Tool  Flat screwdriver Ø 4 mm Ø 0.16 in
	Flexible	0.2 ... 1.5 mm <sup>2</sup>	24 ... 16 AWG	
	with twin ferrule	0.2 ... 1.5 mm <sup>2</sup>	24 ... 16 AWG	
Rated current / Rated cross section		24 A / 2.5 mm <sup>2</sup>	25 A / 10 AWG	Torque  0.5 N.m ± 0.1 4.4 lb.in ± 0.9
Rated short-time withstand current (1s)		300 A		
Short Circuit Current Rating (with specific conditions)				
Rated voltage		1000 V	600 V	
Impulse withstand voltage		8000 V		
Protection		IP20	NEMA 1	

The connecting capacity data for one Rigid - Solid / Stranded - Flexible conductor (when applicable) is a mandatory information required by IEC, UL and CSA standards (Copper conductors). All other data are provided as supplementary information only. For more details, please consult our CB, UL or CSA certificates and technical datasheet available on <http://www.te.com>

CE	RoHS	USR	EAC

## Accessories

Description	Color	Type	Part Numbers	Pkg qty	Weight (1 pce) g		
1 End stops	Grey <input type="checkbox"/>	BAM4	1SNK900001R0000	50	12.00		
		BAZ1	1SNK900002R0000	50	4.70		
2 End sections	Grey <input type="checkbox"/>	EP5-6	1SNL900100R0000	20	1.6		
3 Jumper bars	Grey <input type="checkbox"/>	2 poles	32 (IEC)	BJC16-2	1SNL906602R0000	10	3.95
		3 poles	32 (IEC)	BJC16-3	1SNL906603R0000	10	5.9
		4 poles	32 (IEC)	BJC16-4	1SNL906604R0000	10	7.9
		5 poles	32 (IEC)	BJC16-5	1SNL906605R0000	10	9.87
		10 poles	32 (IEC)	BJC16-10	1SNL906610R0000	10	19.7
		4 Lateral jumper bars	Grey <input type="checkbox"/>	2 poles	35 (IEC)	PC6-2	1SNA113546R1400
3 poles	35 (IEC)			PC6-3	1SNA116536R0500	10	2.00
4 poles	35 (IEC)			PC6-4	1SNA116537R0600	10	3.00
10 poles	35 (IEC)			PC6-10	1SNA113548R2600	10	8.00
25 poles	24 (IEC)			LJB6-25E	1SNL906751R0000	10	17.5
50 poles	24 (IEC)			LJB6-50	1SNL906750R0000	10	25.5
5 Circuit separators	Grey <input type="checkbox"/>	CS5-6	1SNL900101R0000	10	1.16		
6 Terminal block markers	White <input type="checkbox"/>	Blank card	RC610TT	1SNA233600R1700	22	12	
			RC610	1SNA233000R0100	10	7.50	

Complete list of accessories is indicated in the terminal block datasheet including end stops. Some accessories such as jumper bars may modify the terminal block's ratings: Complete information available in the accessories section of the catalog.

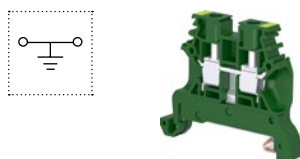

## Ground screw clamp terminal blocks

Description	Color	Type	Part Numbers	Pkg qty	Weight (1 pce) g
Ground	Green-yellow <input type="checkbox"/>	C2.5/6.P	1SNL606151R0000	100	10.2

Technical data valid for copper conductors only.

# C4/6 screw clamp terminal blocks

Feed-through - 6 mm 0.24 in spacing

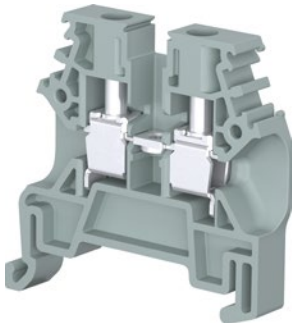
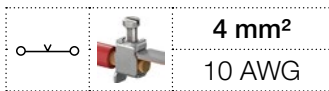

C4/6

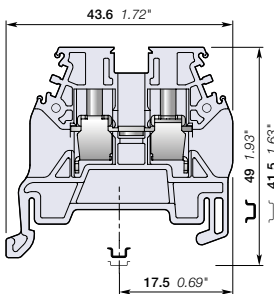

6 mm 0.24 in spacing

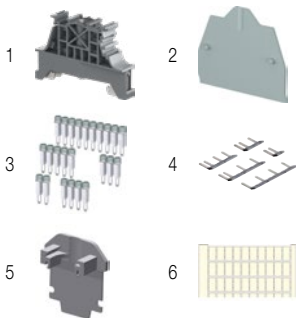

## Description

– 4 mm<sup>2</sup> feed-through terminal with TE screw clamp connection

## Ordering details

Description	Color	Type	Part Numbers	Pkg qty	Weight (1 pce) g
Feed-through 2 connections	Grey <input type="checkbox"/>	C4/6	1SNL606010R0000	100	6.4
	Blue <input checked="" type="checkbox"/>	C4/6.N	1SNL606020R0000	100	6.4

## Main technical data

Connecting capacity		IEC	UL - CSA	Mounting instructions	
1 conductor per clamp	Rigid - Solid / Stranded	0.2 ... 6 mm <sup>2</sup>	24 ... 10 AWG	Rail	TH 35-7.5, TH 35-15
	Flexible	0.2 ... 4 mm <sup>2</sup>		Wire stripping length	10 mm 0.39 in
	with non insulated ferrule	0.2 ... 4 mm <sup>2</sup>	24 ... 10 AWG		
	with insulated ferrule	0.2 ... 4 mm <sup>2</sup>	24 ... 12 AWG		
Gauge		A4			
2 conductors per clamp	Rigid - Solid / Stranded	0.2 ... 2.5 mm <sup>2</sup>	24 ... 14 AWG	Tool	Flat screwdriver Ø 4 mm 0.16 in
	Flexible with twin ferrule	0.2 ... 2.5 mm <sup>2</sup>	24 ... 16 AWG		
Rated current / Rated cross section		32 A / 4 mm <sup>2</sup>	30 A / 10 AWG	Torque	0.65 N.m ± 0.15 5.75 lb.in ± 1.35
Rated short-time withstand current (1s)		480 A			
Short Circuit Current Rating (with specific conditions)					
Rated voltage		1000 V	600 V		
Impulse withstand voltage		8000 V			
Protection		IP20	NEMA 1		

The connecting capacity data for one Rigid - Solid / Stranded - Flexible conductor (when applicable) is a mandatory information required by IEC, UL and CSA standards (Copper conductors). All other data are provided as supplementary information only. For more details, please consult our CB, UL or CSA certificates and technical datasheet available on <http://www.te.com>

CE	RoHS	UL	EAC		

## Accessories

Description	Color	Type	Part Numbers	Pkg qty	Weight (1 pce) g	
1 End stops	Grey <input type="checkbox"/>	BAM4	1SNK900001R0000	50	12.00	
		BAZ1	1SNK900002R0000	50	4.70	
2 End sections	Grey <input type="checkbox"/>	EP5-6	1SNL900100R0000	20	1.6	
3 Jumper bars	Grey <input type="checkbox"/>	2 poles	BJC16-2	1SNL906602R0000	10	3.95
		3 poles	BJC16-3	1SNL906603R0000	10	5.9
		4 poles	BJC16-4	1SNL906604R0000	10	7.9
		5 poles	BJC16-5	1SNL906605R0000	10	9.87
		10 poles	BJC16-10	1SNL906610R0000	10	19.7
		2 poles	PC6-2	1SNA113546R1400	10	2.00
4 Lateral jumper bars	Grey <input type="checkbox"/>	3 poles	PC6-3	1SNA116536R0500	10	2.00
		4 poles	PC6-4	1SNA116537R0600	10	3.00
		10 poles	PC6-10	1SNA113548R2600	10	8.00
		25 poles	LJB6-25E	1SNL906751R0000	10	17.5
		50 poles	LJB6-50	1SNL906750R0000	10	25.5
5 Circuit separators	Grey <input type="checkbox"/>	CS5-6	1SNL900101R0000	10	1.16	
6 Terminal block markers	White <input type="checkbox"/>	RC610TT	1SNA233600R1700	22	12	
		RC610	1SNA233000R0100	10	7.50	

Complete list of accessories is indicated in the terminal block datasheet including end stops. Some accessories such as jumper bars may modify the terminal block's ratings: Complete information available in the accessories section of the catalog.

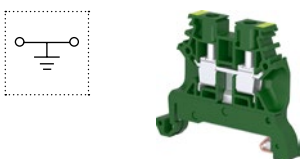

## Ground screw clamp terminal blocks

Description	Color	Type	Part Numbers	Pkg qty	Weight (1 pce) g
Ground	Green-yellow <input checked="" type="checkbox"/>	C4/6.P	1SNL606150R0000	100	10.2

Technical data valid for copper conductors only.

# M4/6.3A screw clamp terminal blocks

Feed-through - 6 mm 0.236 in spacing



M4/6.3A

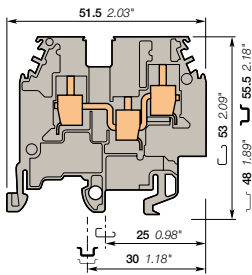

6 mm 0.236 in spacing

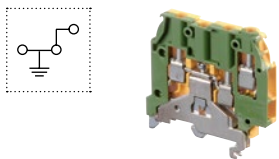
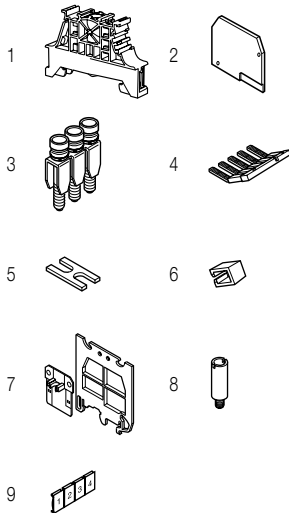

## Description

- Ease one potential distribution on 3 independent screw clamps,
- Flexibility: snap onto symmetrical and asymmetrical rails.

## Ordering details

Description	Color	Type	Part Number	Pkg qty	Weight (1 pce) g
Feed-through	Grey <input type="checkbox"/>	M4/6.3A	1SNA115468R2000	50	11.00
	Blue <input type="checkbox"/>	M4/6.3A.N	1SNA125468R2200	50	11.00

## Main technical data

Connecting capacity		IEC	UL	CSA	Mounting instructions	
1 conductor per clamp	Rigid: Solid/Stranded	0.2-4 mm <sup>2</sup>	22-10 AWG	12 AWG	Rail	G32, TH 35-7.5, TH 35-15
	Flexible without ferrule	0.22-4 mm <sup>2</sup>			Wire stripping length	9.5 mm 0.37 in
	Flexible with insulated ferrule				Tool	Flat screwdriver Ø 4 mm Ø 0.157 in
	Gauge	A4			Torque	0.5 - 0.8 N.m 4.4 - 7.1 lb.in
Rated current / Rated cross section		32 A / 4 mm <sup>2</sup>	20 A / 10 AWG	25 A / 12 AWG		
Rated short-time withstand current (1s)		480 A				
Rated voltage		800 V	600 V	600 V		
Impulse withstand voltage		8000 V				
Protection		IP20	NEMA 1			

The connecting capacity data for one Rigid: Solid/Stranded, or one Flexible conductor (when applicable) is a mandatory information required by IEC, UL and CSA standards (Copper conductors). All other data are provided as supplementary information only. For more details, please consult our CB, UL or CSA certificates and technical datasheet available on <http://www.TE.com>

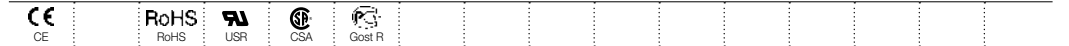

## Accessories

Description	Color	Type	Part Number	Pkg qty	Weight (1 pce) g	
1 End stops	Grey <input type="checkbox"/>	BAM4	1SNK900001R0000	50	12.00	
		BAZ1	1SNK900002R0000	50	4.70	
2 End sections	Grey <input type="checkbox"/>	FEM3A	1SNA116576R1500	20	3.30	
3 Jumper bars	Grey <input type="checkbox"/>	2 poles	BJM6-2	1SNA176663R0000	10	4.40
		3 poles	BJM6-3	1SNA176664R0100	10	6.70
		4 poles	BJM6-4	1SNA176665R0200	10	8.90
		5 poles	BJM6-5	1SNA176666R0300	10	11.20
		10 poles	BJM6-10	1SNA176667R0400	10	22.40
4 Lateral jumper bars	Grey <input type="checkbox"/>	2 poles	PC6-2	1SNA113546R1400	10	2.00
		10 poles	PC6-10	1SNA113548R2600	10	8.00
5 Cross spacing jumpers	Grey <input type="checkbox"/>	5 mm 0.200 in - 6 mm 0.236 in - 8 mm 0.315 in	EL6	1SNA173627R2100	10	0.10
		Universal screw jumper bar kit N°I	BJDP1	1SNA179623R0300	10	7.00
		Universal screw jumper bar kit N°III	BJDP3	1SNA179625R0500	10	5.00
6 Insulating tips	Grey <input type="checkbox"/>	EIP	1SNA113550R2400	10		
7 Circuit separators	Grey <input type="checkbox"/>	SCM6	1SNA113003R1000	10	0.30	
8 Test sockets	White <input type="checkbox"/>	DIA 2 mm 0.079 in	AL2	1SNA163043R2100	50	0.90
		DIA 3 mm 0.120 in	AL3	1SNA163261R0000	50	1.20
9 Terminal block markers	White <input type="checkbox"/>	Blank card	RC610TT	1SNA233600R1700	22	12
			RC610	1SNA233000R0100	1	7.50

Complete list of accessories is indicated in the terminal block datasheet. Some accessories such as jumper bars may modify the terminal block's ratings: complete information in the accessories catalogue pages.

## Ground screw clamp terminal blocks

Description	Color	Type	Part Number	Pkg qty	Weight (1 pce) g
Ground	Green-yellow <input type="checkbox"/>	M4/6.3A.P	1SNA195637R1200	50	22.00

Technical data valid for copper conductors only.

# M4/6.4A screw clamp terminal blocks

Feed-through - 6 mm 0.236 in spacing

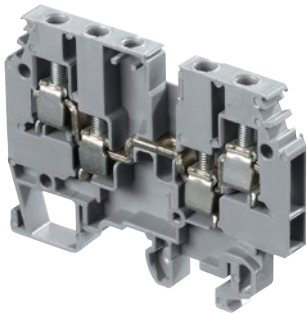

M4/6.4A

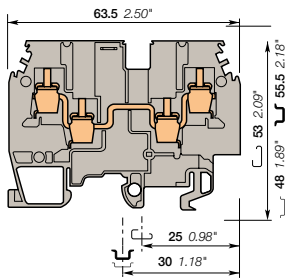

6 mm 0.236 in spacing

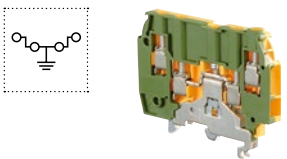
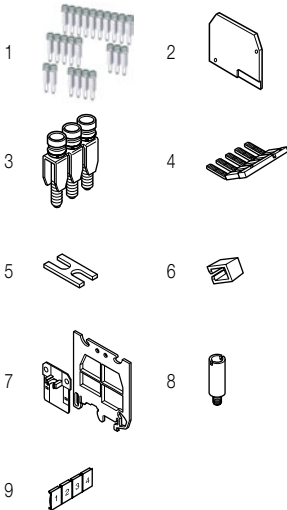

## Description

- Ease one potential distribution on 4 independent screw clamps,
- Flexibility: snap onto symmetrical and asymmetrical rails.

## Ordering details

Description	Color	Type	Part Number	Pkg qty	Weight (1 pce) g
Feed-through	Grey <input type="checkbox"/>	M4/6.4A	1SNA115479R2300	50	20.00
	Blue <input type="checkbox"/>	M4/6.4A.N	1SNA125479R2500	50	20.00

## Main technical data

Connecting capacity		IEC	UL	CSA	Mounting instructions	
1 conductor per clamp	Rigid: Solid/Stranded	0.2-4 mm²	22-10 AWG	12 AWG	Rail	G32, TH 35-7.5, TH 35-15
	Flexible without ferrule	0.22-4 mm²			Wire stripping length	9.5 mm / 0.37 in
	Flexible with insulated ferrule				Tool	Flat screwdriver Ø 4 mm / Ø 0.157 in
	Gauge	A4			Torque	0.5 - 0.8 N.m / 4.4 - 7.1 lb.in
Rated current / Rated cross section		32 A / 4 mm²	20 A / 10 AWG	25 A / 12 AWG		
Rated short-time withstand current (1s)		480 A				
Rated voltage		800 V	600 V	600 V		
Impulse withstand voltage		8000 V				
Protection		IP20	NEMA 1			

The connecting capacity data for one Rigid: Solid/Stranded, or one Flexible conductor (when applicable) is a mandatory information required by IEC, UL and CSA standards (Copper conductors). All other data are provided as supplementary information only. For more details, please consult our CB, UL or CSA certificates and technical datasheet available on <http://www.te.com>

--	--	--	--	--	--	--	--	--	--

## Accessories

Description	Color	Type	Part Number	Pkg qty	Weight (1 pce) g		
1 End stops	Grey <input type="checkbox"/>	BAM4	1SNK900001R0000	50	12.00		
		BAZ1	1SNK900002R0000	50	4.70		
2 End sections	Grey <input type="checkbox"/>	FEM4A	1SNA116629R2200	20	3.80		
3 Jumper bars		2 poles	32 A	BJMI6-2	1SNA176663R0000	10	4.40
		3 poles		BJMI6-3	1SNA176664R0100	10	6.70
		4 poles		BJMI6-4	1SNA176665R0200	10	8.90
		5 poles		BJMI6-5	1SNA176666R0300	10	11.20
		10 poles		BJMI6-10	1SNA176667R0400	10	22.40
4 Lateral jumper bars	Grey <input type="checkbox"/>	2 poles	35 A	PC6-2	1SNA113546R1400	10	2.00
		10 poles		PC6-10	1SNA113548R2600	10	8.00
5 Cross spacing jumpers		5 mm 0.200 in - 6 mm 0.236 in - 8 mm 0.315 in		EL6	1SNA173627R2100	10	0.10
		Universal screw jumper bar kit N <sup>I</sup>		BJDP1	1SNA179623R0300	10	7.00
		Universal screw jumper bar kit N <sup>III</sup>		BJDP3	1SNA179625R0500	10	5.00
6 Insulating tips		For lateral jumper bars type PC...	EIP	1SNA113550R2400	10		
7 Circuit separators	Grey <input type="checkbox"/>		SCM6	1SNA113003R1000	10	0.30	
8 Test sockets		DIA 2 mm 0.079 in		AL2	1SNA163043R2100	50	0.90
		DIA 3 mm 0.120 in		AL3	1SNA163261R0000	50	1.20
9 Terminal block markers	White <input type="checkbox"/>	Blank card		RC610TT	1SNA233600R1700	22	12
				RC610	1SNA233000R0100	1	7.50

Complete list of accessories is indicated in the terminal block datasheet.

Some accessories such as jumper bars may modify the terminal block's ratings: complete information in the accessories catalogue pages.

## Ground screw clamp terminal blocks

Description	Color	Type	Part Number	Pkg qty	Weight (1 pce) g
Ground	Green-yellow <input type="checkbox"/>	M4/6.4A.P	1SNA195638R2300	50	22.00

Technical data valid for copper conductors only.

# C6/8 screw clamp terminal blocks

Feed-through - 8 mm 0.31 in spacing

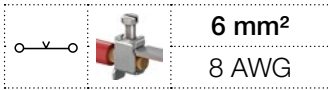

6 mm<sup>2</sup>  
8 AWG

## Description

– 6 mm<sup>2</sup> feed-through terminal with TE screw clamp connection

## Ordering details

Description	Color	Type	Part Numbers	Pkg qty	Weight (1 pce) g
Feed-through 2 connections	Grey <input type="checkbox"/>	C6/8	1SNL608010R0000	50	12.8
	Blue <input type="checkbox"/>	C6/8.N	1SNL608020R0000	50	12.8

## Main technical data

Connecting capacity		IEC	UL - CSA	Rail	Mounting instructions
1 conductor per clamp	Rigid - Solid / Stranded	0.5 ... 10 mm <sup>2</sup>	20 ... 8 AWG	Wire stripping length	 TH 35-7.5, TH 35-15 12 mm 0.47 in
	Flexible	0.5 ... 6 mm <sup>2</sup>	20 ... 8 AWG		
	with non insulated ferrule	0.5 ... 6 mm <sup>2</sup>	20 ... 8 AWG	Tool	 Flat screwdriver Ø 4-5 mm Ø 0.16-0.2 in
	with insulated ferrule	0.5 ... 6 mm <sup>2</sup>	20 ... 10 AWG		
2 conductors per clamp	Rigid - Solid / Stranded	0.5 ... 4 mm <sup>2</sup>	20 ... 12 AWG	Torque	 0.9 N.m ± 0.1 8 lb.in ± 0.9
	Flexible with twin ferrule	0.5 ... 4 mm <sup>2</sup>	20 ... 14 AWG		
Rated current / Rated cross section		41 A / 6 mm <sup>2</sup>	45 A / 8 AWG		
Rated short-time withstand current (1s)		720 A			
Short Circuit Current Rating (with specific conditions)					
Rated voltage		1000 V	600 V		
Impulse withstand voltage		8000 V			
Protection		IP20	NEMA 1		

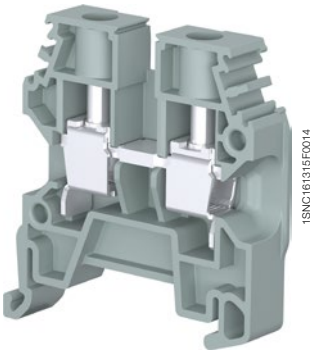

C6/8

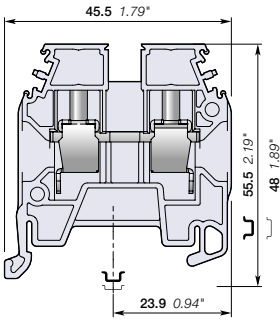

8 mm 0.31 in spacing

The connecting capacity data for one Rigid - Solid / Stranded - Flexible conductor (when applicable) is a mandatory information required by IEC, UL and CSA standards (Copper conductors). All other data are provided as supplementary information only. For more details, please consult our CB, UL or CSA certificates and technical datasheet available on <http://www.te.com>

CE	RoHS	USA	EAC
CE	RoHS	USA	EAC

## Accessories

Description	Color	Type	Part Numbers	Pkg qty	Weight (1 pce) g		
1 End stops	Grey <input type="checkbox"/>	BAM4	1SNK900001R0000	50	12.00		
		BAZ1	1SNK900002R0000	50	4.70		
2 End sections	Grey <input type="checkbox"/>	FEM6	1SNA118368R1600	20	2.40		
3 Jumper bars	Grey <input type="checkbox"/>	2 poles	41 (IEC)	BJM8-2	1SNA176669R1600	10	4.50
		3 poles	41 (IEC)	BJM8-3	1SNA176670R1300	10	6.00
		4 poles	41 (IEC)	BJM8-4	1SNA176671R0000	10	10.00
		5 poles	41 (IEC)	BJM8-5	1SNA176672R0100	10	12.20
		10 poles	41 (IEC)	BJM8-10	1SNA176673R0200	10	20.00
4 Lateral jumper bars	Black <input type="checkbox"/>	2 poles	50 (IEC)	PC8-2	1SNA116538R1700	10	3.00
		10 poles	50 (IEC)	PC8-10	1SNA163313R2400	10	14.00
5 Circuit separators	Grey <input type="checkbox"/>	SCM6	1SNA113003R1000	10	0.30		
6 Terminal block markers	White <input type="checkbox"/>	Blank card	RC810TT	1SNA234600R1000	22	12	
			RC810	1SNA234000R0200	10	8.20	

Complete list of accessories is indicated in the terminal block datasheet including end stops. Some accessories such as jumper bars may modify the terminal block's ratings: Complete information available in the accessories section of the catalog.



## Ground screw clamp terminal blocks

Description	Color	Type	Part Numbers	Pkg qty	Weight (1 pce) g
Ground	Green-yellow <input type="checkbox"/>	C6/8.P	1SNL608150R0000	50	15.2

Technical data valid for copper conductors only.



# C10/10 screw clamp terminal blocks

Feed-through - 10 mm 0.39 in spacing

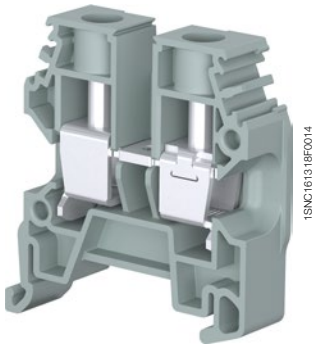
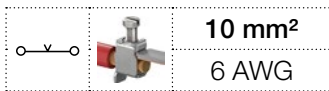

C10/10

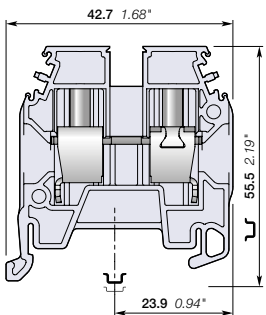

10 mm 0.39 in spacing

## Description

– 10 mm<sup>2</sup> feed-through terminal with TE screw clamp connection

## Ordering details

Description	Color	Type	Part Numbers	Pkg qty	Weight (1 pce) g
Feed-through 2 connections	Grey <input type="checkbox"/>	C10/10	1SNL610010R0000	50	16.1
	Blue <input type="checkbox"/>	C10/10.N	1SNL610020R0000	50	16.1

## Main technical data

Connecting capacity		IEC	UL - CSA	Mounting instructions	
1 conductor per clamp	Rigid - Solid / Stranded	0.5 ... 16 mm <sup>2</sup>	20 ... 6 AWG	Rail	 TH 35-7.5, TH 35-15
	Flexible	0.5 ... 10 mm <sup>2</sup>			
	with non insulated ferrule	0.5 ... 10 mm <sup>2</sup>	20 ... 6 AWG	Wire stripping length	 12 mm 0.47 in
	with insulated ferrule	0.5 ... 10 mm <sup>2</sup>	20 ... 8 AWG		
Gauge		B6			
2 conductors per clamp	Rigid - Solid / Stranded	0.5 ... 6 mm <sup>2</sup>	20 ... 10 AWG	Tool	 Flat screwdriver Ø 5.5-6 mm Ø 0.22-0.24 in
	Flexible	0.5 ... 6 mm <sup>2</sup>			
	with twin ferrule	0.5 ... 6 mm <sup>2</sup>	20 ... 12 AWG		
Rated current / Rated cross section		57 A / 10 mm <sup>2</sup>	59 A / 6 AWG	Torque	 1.3 N.m ± 0.1 11.5 lb.in ± 0.9
Rated short-time withstand current (1s)		1200 A			
Short Circuit Current Rating (with specific conditions)					
Rated voltage		1000 V	600 V		
Impulse withstand voltage		8000 V			
Protection		IP20	NEMA 1		

The connecting capacity data for one Rigid - Solid / Stranded - Flexible conductor (when applicable) is a mandatory information required by IEC, UL and CSA standards (Copper conductors). All other data are provided as supplementary information only. For more details, please consult our CB, UL or CSA certificates and technical datasheet available on <http://www.te.com>

CE	RoHS	RoHS	USR	ERC	EAC
----	------	------	-----	-----	-----

## Accessories

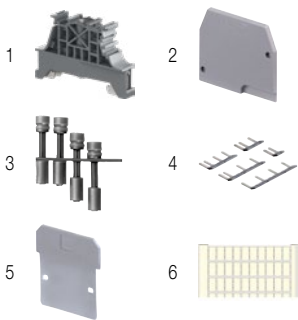

Description	Color	Type	Part Numbers	Pkg qty	Weight (1 pce) g	
1 End stops	Grey <input type="checkbox"/>	BAM 4	1SNK900001R0000	50	12.00	
		BAZ1	1SNK900002R0000	50	4.70	
2 End sections	Grey <input type="checkbox"/>	FEM6	1SNA118368R1600	20	2.40	
3 Jumper bars		2 poles	BJMI10-2	1SNA176675R0400	10	5
		3 poles	BJMI10-3	1SNA176676R0500	10	8.00
		4 poles	BJMI10-4	1SNA176677R0600	10	11.00
		5 poles	BJMI10-5	1SNA176678R1700	10	13.00
		10 poles	BJMI10-10	1SNA176679R1000	10	27.00
		4 Lateral jumper bars		10 poles	PC10-10	1SNA163315R2600
5 Circuit separators	Grey <input type="checkbox"/>	SCM6	1SNA113003R1000	10	0.30	
6 Terminal block markers	White <input type="checkbox"/>	RC810TT	1SNA234600R1000	22	12	
		RC1010	1SNA238000R1600	10	1.30	

Complete list of accessories is indicated in the terminal block datasheet including end stops. Some accessories such as jumper bars may modify the terminal block's ratings: Complete information available in the accessories section of the catalog.



## Ground screw clamp terminal blocks

Description	Color	Type	Part Numbers	Pkg qty	Weight (1 pce) g
Ground	Green-yellow <input type="checkbox"/>	C10/10.P	1SNL610150R0000	50	22.5

Technical data valid for copper conductors only.

# C16/12 screw clamp terminal blocks

Feed-through - 12 mm 0.47 in spacing

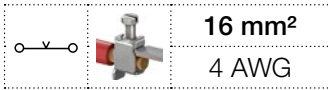

**16 mm<sup>2</sup>**  
**4 AWG**

## Description

– 16 mm<sup>2</sup> feed-through terminal with TE screw clamp connection

## Ordering details

Description	Color	Type	Part Numbers	Pkg qty	Weight (1 pce) g
Feed-through 2 connections	Grey <input type="checkbox"/>	C16/12	1SNL612010R0000	50	18
	Blue <input type="checkbox"/>	C16/12.N	1SNL612020R0000	50	18

## Main technical data

Connecting capacity	IEC	UL - CSA	Mounting instructions
<b>1 conductor per clamp</b>	Rigid - Solid / Stranded Flexible with non insulated ferrule with insulated ferrule Gauge	0.5 ... 16 mm <sup>2</sup> 0.5 ... 16 mm <sup>2</sup> 0.5 ... 16 mm <sup>2</sup> 0.5 ... 16 mm <sup>2</sup> B6	20 ... 4 AWG 20 ... 4 AWG 20 ... 6 AWG
<b>2 conductors per clamp</b>	Rigid - Solid / Stranded Flexible with twin ferrule	0.5 ... 10 mm <sup>2</sup> 0.5 ... 10 mm <sup>2</sup> 0.5 ... 10 mm <sup>2</sup>	20 ... 8 AWG 20 ... 10 AWG
<b>Rated current / Rated cross section</b>		76 A / 16 mm <sup>2</sup>	80 A / 4 AWG
<b>Rated short-time withstand current (1s)</b>		1920 A	
<b>Short Circuit Current Rating (with specific conditions)</b>			
<b>Rated voltage</b>		1000 V	600 V
<b>Impulse withstand voltage</b>		8000 V	
<b>Protection</b>		IP20	NEMA 1

## Mounting instructions

Tool	Illustration	Dimensions
Wire stripping length		12 mm 0.47 in
Flat screwdriver		Ø 5.5-6 mm Ø 0.22-0.24 in
Torque		1.3 N.m ± 0.1 11.5 lb.in ± 0.9

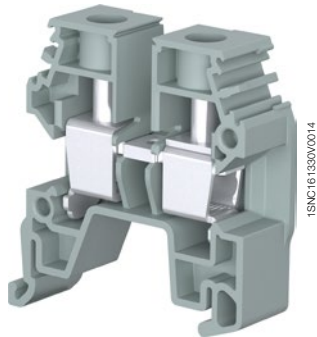

C16/12

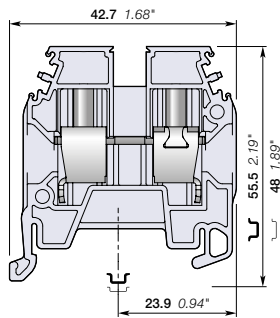

12 mm 0.47 in spacing

The connecting capacity data for one Rigid - Solid / Stranded - Flexible conductor (when applicable) is a mandatory information required by IEC, UL and CSA standards (Copper conductors). All other data are provided as supplementary information only. For more details, please consult our CB, UL or CSA certificates and technical datasheet available on <http://www.te.com>

--	--	--	--

## Accessories

Description	Color	Type	Part Numbers	Pkg qty	Weight (1 pce) g	
1 <b>End stops</b>	Grey <input type="checkbox"/>	BMA4	1SNK900001R0000	50	12.00	
		BAZ1	1SNK900002R0000	50	4.70	
2 <b>End sections</b>	Grey <input type="checkbox"/>	FEM6	1SNA118368R1600	20	2.40	
3 <b>Jumper bars</b>	Grey <input type="checkbox"/>	2 poles	BJMI12-2	1SNA179626R0600	10	6.00
		3 poles	BJMI12-3	1SNA179628R1000	10	9.00
		4 poles	BJMI12-4	1SNA179629R1100	10	13.00
		5 poles	BJMI12-5	1SNA179630R1600	10	16.00
		10 poles	BJMI12-10	1SNA179631R0300	10	33.00
4 <b>Circuit separators</b>	Grey <input type="checkbox"/>	SCM6	1SNA113003R1000	10	0.30	
5 <b>Terminal block markers</b>	White <input type="checkbox"/>	RC810TT	1SNA234600R1000	22	12	
		RC1010	1SNA238000R1600	10	1.30	

Complete list of accessories is indicated in the terminal block datasheet including end stops. Some accessories such as jumper bars may modify the terminal block's ratings: Complete information available in the accessories section of the catalog.

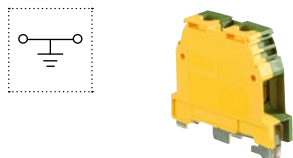
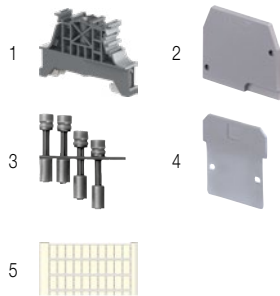

## Ground screw clamp terminal blocks

Description	Color	Type	Part Numbers	Pkg qty	Weight (1 pce) g
Ground	Green-yellow <input type="checkbox"/>	M16/12.P	1SNA165130R2300	20	40

Technical data valid for copper conductors only.

# M35/16 screw clamp terminal blocks

Feed-through - 16 mm 0.630 in spacing



M35/16

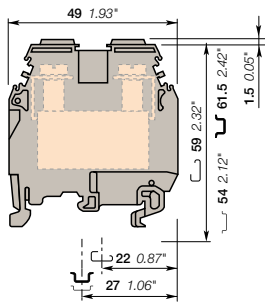

16 mm 0.630 in spacing

## Description

- Closed terminal block: no end section needed, optimized rigidity,
- Flexibility: snap onto symmetrical and asymmetrical rails,
- Use of jumper bars requires the user to cut out the partition.

## Ordering details

Description	Color	Type	Part Number	Pkg qty	Weight (1 pce) g
Feed-through Closed block with partition	Grey	M35/16	1SNA115124R0700	20	50.00
	Blue	M35/16.N	1SNA125124R0100	20	50.00
	Yellow	M35/16	1SNA105124R1600	20	50.00
	Red	M35/16	1SNA400195R2200	20	50.00
	White	M35/16	1SNA400196R2300	20	50.00
	Black	M35/16	1SNA400194R2100	20	50.00
	Beige	M35/16	1SNA195124R0000	20	50.00

## Main technical data

Connecting capacity		IEC	UL	CSA	Rail	Wire stripping length	Tool	Torque
1 conductor per clamp	Rigid: Solid/Stranded	6-50 mm <sup>2</sup>	10-0 AWG	10-0 AWG	G32, TH 35-7.5, TH 35-15	17 mm	Flat screwdriver	2.8 - 3 N.m
	Flexible without ferrule	6-35 mm <sup>2</sup>				0.669 in	Ø 6.5 - 7 mm	24.9 - 26.7 lb.in
	Flexible with insulated ferrule						Ø 0.255 - 0.276 in	
	Gauge	B9						
Rated current / Rated cross section		125 A / 35 mm <sup>2</sup>	150 A / 0 AWG	150 A / 0 AWG				
Rated short-time withstand current (1s)		4200 A						
Rated voltage		1000 V	600 V	600 V				
Impulse withstand voltage		8000 V						
Protection		IP10	NEMA					

The connecting capacity data for one Rigid: Solid/Stranded, or one Flexible conductor (when applicable) is a mandatory information required by IEC, UL and CSA standards (Copper conductors). All other data are provided as supplementary information only. For more details, please consult our CB, UL or CSA certificates and technical datasheet available on <http://www.te.com>



## Accessories

Description	Color	Type	Part Number	Pkg qty	Weight (1 pce) g	
1 End stops	Grey	BAM4	1SNK900001R0000	50	12.00	
		BAZ1	1SNK900002R0000	50	4.70	
2 Jumper bars	Orange	2 poles	1SNK916302R0000	10	10.20	
		3 poles	1SNK916303R0000	10	16.00	
		4 poles	1SNK916304R0000	10	21.80	
		5 poles	1SNK916305R0000	10	27.60	
		10 poles	1SNK916310R0000	10	56.60	
		Universal screw jumper bar kit N°I	BJDP1	1SNA179623R0300	10	7.00
3 Cross spacing jumpers		Universal screw jumper bar kit N°II	BJDP2	1SNA179624R0400	10	6.00
			SCFCV1-2	1SNA116795R1100	10	8.00
4 Circuit separators	Grey					
5 Test sockets		AL4-M4	1SNA206723R0300	50	1.30	
6 Test plugs	White	FC4	1SNA167860R0100	10		
7 Protecting covers	Transparent	CPV1-2	1SNA176816R1200	1		
		RC810TT	1SNA234600R1000	22	12	
8 Terminal block markers	White	RC1010	1SNA238000R1600	10	1.30	

Complete list of accessories is indicated in the terminal block datasheet. Some accessories such as jumper bars may modify the terminal block's ratings: complete information in the accessories catalogue pages.

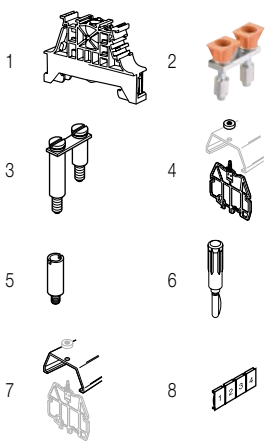

## Ground screw clamp terminal blocks

Description	Color	Type	Part Number	Pkg qty	Weight (1 pce) g
Ground Profile aligned with M35/16...	Green-yellow	M35/16.P	1SNA165111R1400	20	50.50

Technical data valid for copper conductors only.

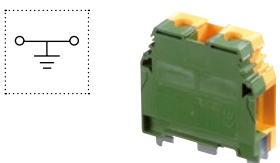



# D70/22 screw clamp terminal blocks

Feed-through - 22 mm 0.866 in spacing

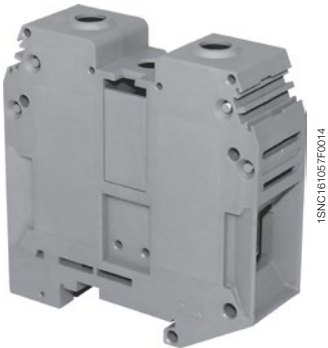

D70/22

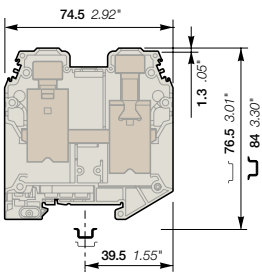

22 mm 0.866 in spacing

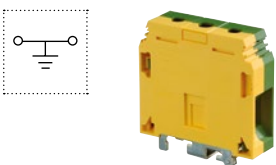
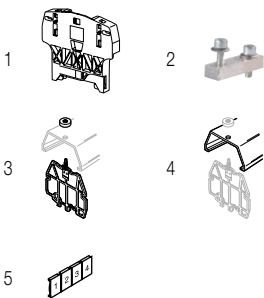

## Description

- Closed terminal block: no end section needed, optimized rigidity,
- Use of jumper bars requires the user to cut out the partition.

## Ordering details

Description	Color	Type	Part Number	Pkg qty	Weight (1 pce) g
Feed-through Closed block	Grey <input type="checkbox"/>	D70/22	1SNA400305R1000	10	158.10
	Blue <input type="checkbox"/>	D70/22.N	1SNA400306R1100	10	158.10
	Yellow <input type="checkbox"/>	D70/22.YL	1SNA400789R0000	10	158.10

## Main technical data

Connecting capacity		IEC	UL	CSA	Mounting instructions	
1 conductor per clamp	Rigid: Solid/Stranded	16-95 mm²	4-00 AWG	4-00 AWG	Rail	TH 35-7.5, TH 35-15
	Flexible without ferrule	16-70 mm²			Wire stripping length	25 mm 0.98 in
	Flexible with insulated ferrule				Tool	Allen key Ø 6 mm Ø 0.236 in
	Gauge	B11			Torque	6 - 7 N.m 53.4 - 62.3 lb.in
Rated current / Rated cross section		192 A / 70 mm²	159 A / 00 AWG	159 A / 00 AWG		
Rated short-time withstand current (1s)		8400 A				
Rated voltage		1000 V	600 V	600 V		
Impulse withstand voltage		8000 V				
Protection		IP10	NEMA			

The connecting capacity data for one Rigid: Solid/Stranded, or one Flexible conductor (when applicable) is a mandatory information required by IEC, UL and CSA standards (Copper conductors). All other data are provided as supplementary information only. For more details, please consult our CB, UL or CSA certificates and technical datasheet available on <http://www.te.com>

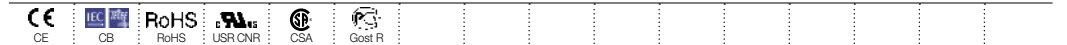

## Accessories

Description	Color	Type	Part Number	Pkg qty	Weight (1 pce) g
1 End stops	Grey <input type="checkbox"/>	BAZH1	1SNK900102R0000	50	24.00
2 Jumper bars		JB22-2	1SNK922302R0000	5	27.00
		JB22-3	1SNK922303R0000	5	43.30
		JB22-5	1SNK922305R0000	5	76.10
		JB22-10	1SNK922310R0000	5	157.40
3 Circuit separators	Grey <input type="checkbox"/>	SCFCV4	1SNA116797R1300	10	
4 Protecting covers	Transparent <input checked="" type="checkbox"/>	CPV4-5	1SNA176791R2100	1	
5 Terminal block markers	White <input type="checkbox"/>	RC810TT	1SNA234600R1000	22	12
		RC1010	1SNA238000R1600	1	1.30

Complete list of accessories is indicated in the terminal block datasheet. Some accessories such as jumper bars may modify the terminal block's ratings: complete information in the accessories catalogue pages.

## Ground screw clamp terminal blocks

Description	Color	Type	Part Number	Pkg qty	Weight (1 pce) g
Ground	Green-yellow <input checked="" type="checkbox"/>	D70/22.P	1SNA400772R1300	10	222.00

Technical data valid for copper conductors only.

# D95/26 screw clamp terminal blocks

Feed-through - 26 mm 1.024 in spacing

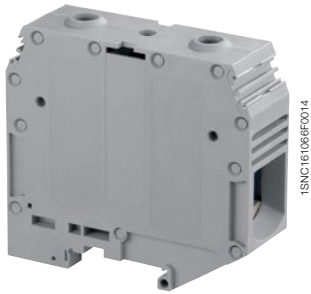

D95/26

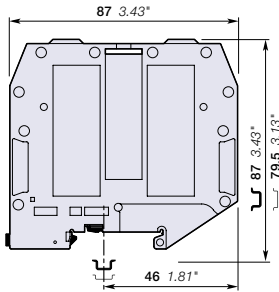

26 mm 1.024 in spacing

## Description

- Closed terminal block: no end section needed, optimized rigidity,
- Use of jumper bars requires the user to cut out the partition.

## Ordering details

Description	Color	Type	Part Number	Pkg qty	Weight (1 pce)
Feed-through Closed block with partition	Grey	D95/26	1SNA400370R2400	10	215.00
	Blue	D95/26.N	1SNA400371R1100	10	215.00
	Yellow	D95/26.YL	1SNA400791R0000	10	215.00

## Main technical data

Connecting capacity	IEC	UL	CSA	Mounting instructions		
1 conductor per clamp	Rigid: Solid/Stranded	35-120 mm <sup>2</sup>	2-0000 AWG	2-0000 AWG	Rail	TH 35-7.5, TH 35-15
	Flexible without ferrule	35-95 mm <sup>2</sup>			Wire stripping length	26 mm 1.02 in
	Flexible with insulated ferrule				Tool	Allen key Ø 6 mm Ø 0.236 in
	Gauge	B12			Torque	9 - 9.5 N.m 79.5 - 83.9 lb.in
Rated current / Rated cross section	232 A / 95 mm <sup>2</sup>	230 A / 0000 AWG	230 A / 0000 AWG			
Rated short-time withstand current (1s)	11400 A					
Rated voltage	1000 V	600 V	600 V			
Impulse withstand voltage	8000 V					
Protection	IP10	NEMA				

The connecting capacity data for one Rigid: Solid/Stranded, or one Flexible conductor (when applicable) is a mandatory information required by IEC, UL and CSA standards (Copper conductors). All other data are provided as supplementary information only. For more details, please consult our CB, UL or CSA certificates and technical datasheet available on <http://www.te.com>

CE	RoHS	UL	CSA	Gost R
CE	RoHS	UL	CSA	Gost R

## Accessories

Description	Color	Type	Part Number	Pkg qty	Weight (1 pce)	
1 End stops	Grey	BZH1	1SNK900102R0000	50	24.00	
2 Jumper bars		2 poles	JB26-2	1SNK926302R0000	5	41.20
		3 poles	JB26-3	1SNK926303R0000	5	65.70
		5 poles	JB26-5	1SNK926305R0000	5	115.70
		10 poles	JB26-10	1SNK926310R0000	5	241.50
3 Terminal block markers	White	Blank card	RC810TT	1SNA234600R1000	22	12
			RC1010	1SNA238000R1600	1	1.30

Complete list of accessories is indicated in the terminal block datasheet.

Some accessories such as jumper bars may modify the terminal block's ratings: complete information in the accessories catalogue pages.

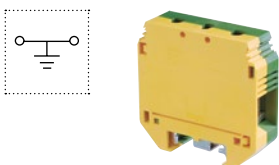
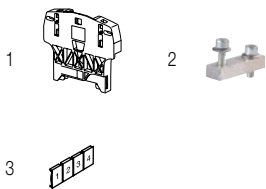

## Ground screw clamp terminal blocks

Description	Color	Type	Part Number	Pkg qty	Weight (1 pce)
Ground Profile aligned with D95/26...	Green-yellow	D95/26.P	1SNA400620R1700	10	278.00

Technical data valid for copper conductors only.

# C2.5/5.P screw clamp terminal blocks

Ground - 5 mm 0.2 in spacing

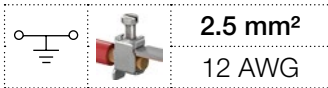

## Description

- Screwless DIN rail contact,
- Reliable electrical and mechanical contact with the rail

## Ordering details

Description	Color	Type	Part Numbers	Pkg qty	Weight (1 pce) g
Ground Screwless DIN rail connection	Green-yellow	C2.5/5.P	1SNL605150R0000	100	8.5

## Main technical data

Connecting capacity		IEC	UL - CSA	Mounting instructions	
1 conductor per clamp	Rigid - Solid / Stranded	0.2 ... 4 mm²	24 ... 12 AWG	Rail	TH 35-7.5, TH 35-15
	Flexible	0.2 ... 2.5 mm²		Wire stripping length	10 mm 0.39 in
	with non insulated ferrule	0.2 ... 4 mm²	24 ... 12 AWG	Tool	Flat screwdriver Ø 3.5 mm Ø 0.14 in
	with insulated ferrule	0.2 ... 2.5 mm²	24 ... 14 AWG		
Gauge		A3		Torque	0.5 N.m ± 0.1 4.4 lb.in ± 0.9
Rated cross section		2.5 mm²	12 AWG	Protection	
Rated short-time withstand current (1s)		300 A		IP20 NEMA 1	

The connecting capacity data for one Rigid - Solid / Stranded - Flexible conductor (when applicable) is a mandatory information required by IEC, UL and CSA standards (Copper conductors). All other data are provided as supplementary information only. For more details, please consult our CB, UL or CSA certificates and technical datasheet available on <http://www.te.com>

--	--	--	--	--	--	--	--	--	--



C2.5/5.P

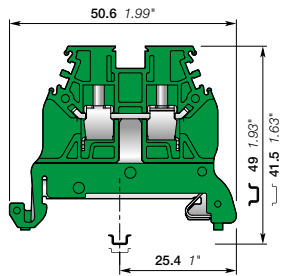

5 mm 0.2 in spacing

## Accessories

Description	Color	Type	Part Numbers	Pkg qty	Weight (1 pce) g
1 End stops	Grey	BAM4	1SNK900001R0000	50	12.00
		BAZ1	1SNK900002R0000	50	4.70
2 End sections	Grey	EP5-6	1SNL900100R0000	20	1.6
3 Terminal block markers	White	RC510TT	1SNA231600R1500	22	12.00
		RC510	1SNA231000R0700	10	5.20

Complete list of accessories is indicated in the terminal block datasheet including end stops. Some accessories such as jumper bars may modify the terminal block's ratings: Complete information available in the accessories section of the catalog.

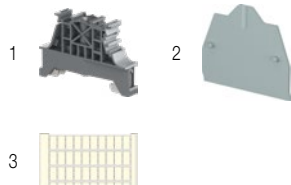

Technical data valid for copper conductors only.

## C2.5/6.P screw clamp terminal blocks

Ground - 6 mm 0.24 in spacing



		<b>2.5 mm<sup>2</sup></b>
		<b>10 AWG</b>

### Description

- Screwless DIN rail contact,
- Reliable electrical and mechanical contact with the rail

### Ordering details

Description	Color	Type	Part Numbers	Pkg qty	Weight (1 pce)
Ground Screwless DIN rail connection	Green-yellow	C2.5/6.P	1SNL606151R0000	100	10.2

### Main technical data

Connecting capacity		IEC	UL - CSA	Mounting instructions	
<b>1 conductor per clamp</b>	Rigid - Solid / Stranded	0.2 ... 4 mm <sup>2</sup>	24 ... 10 AWG	Rail	TH 35-7.5, TH 35-15
	Flexible	0.2 ... 2.5 mm <sup>2</sup>	24 ... 10 AWG	Wire stripping length	10 mm 0.39 in
	with non insulated ferrule	0.2 ... 2.5 mm <sup>2</sup>	24 ... 10 AWG		
	with insulated ferrule	0.2 ... 4 mm <sup>2</sup>	24 ... 12 AWG	Tool	Flat screwdriver Ø 4 mm Ø 0.16 in
Gauge		A3		Torque	0.5 N.m ± 0.1 4.4 lb.in ± 0.9
<b>Rated cross section</b>		2.5 mm <sup>2</sup>	10 AWG		
<b>Rated short-time withstand current (1s)</b>		300 A			
<b>Protection</b>		IP20	NEMA 1		

The connecting capacity data for one Rigid - Solid / Stranded - Flexible conductor (when applicable) is a mandatory information required by IEC, UL and CSA standards (Copper conductors). All other data are provided as supplementary information only. For more details, please consult our CB, UL or CSA certificates and technical datasheet available on <http://www.te.com>

CE	RoHS	UL	EAC						

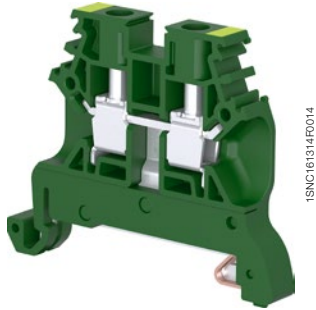

1SNC161314R0014

C2.5/6.P

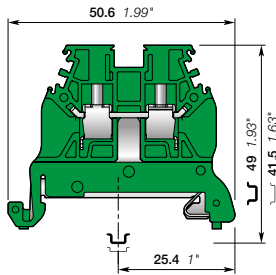

6 mm 0.24 in spacing

### Accessories

Description	Color	Type	Part Numbers	Pkg qty	Weight (1 pce)
<b>1 End stops</b>	Grey <input type="checkbox"/>	BAM4	1SNK900001R0000	50	12.00
		BAZ1	1SNK900002R0000	50	4.70
<b>2 End sections</b>	Grey <input type="checkbox"/>	EP5-6	1SNL900100R0000	20	1.6
<b>3 Terminal block markers</b>	White <input type="checkbox"/>	RC610TT	1SNA233600R1700	22	12
		RC610	1SNA233000R0100	10	7.50

Complete list of accessories is indicated in the terminal block datasheet including end stops. Some accessories such as jumper bars may modify the terminal block's ratings: Complete information available in the accessories section of the catalog.

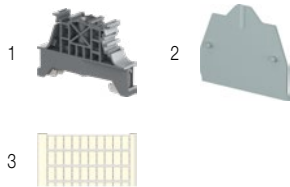

Technical data valid for copper conductors only.

# C4/6.P screw clamp terminal blocks

Ground - 6 mm 0.24 in spacing

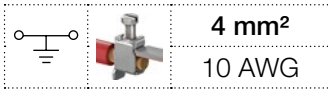

## Description

- Screwless DIN rail contact,
- Reliable electrical and mechanical contact with the rail

## Ordering details

Description	Color	Type	Part Numbers	Pkg qty	Weight (1 pce) g
Ground Screwless DIN rail connection	Green-yellow	C4/6.P	1SNL606150R0000	100	10.2



1SNC161314R0014

C4/6.P

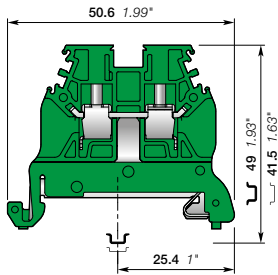

6 mm 0.24 in spacing

## Main technical data

Connecting capacity		IEC	UL - CSA	Mounting instructions	
1 conductor per clamp	Rigid - Solid / Stranded	0.2 ... 6 mm <sup>2</sup>	24 ... 10 AWG	Rail	TH 35-7.5, TH 35-15
	Flexible	0.2 ... 4 mm <sup>2</sup>	24 ... 10 AWG	Wire stripping length	10 mm 0.39 in
	with non insulated ferrule	0.2 ... 4 mm <sup>2</sup>	24 ... 10 AWG	Tool	Flat screwdriver Ø 4 mm Ø 0.16 in
	with insulated ferrule	0.2 ... 4 mm <sup>2</sup>	24 ... 12 AWG		
Gauge		A4		Torque	0.65 N.m ± 0.15 5.75 lb.in ± 1.35
Rated cross section		4 mm <sup>2</sup>	10 AWG		
Rated short-time withstand current (1s)		480 A			
Protection		IP20	NEMA 1		

The connecting capacity data for one Rigid - Solid / Stranded - Flexible conductor (when applicable) is a mandatory information required by IEC, UL and CSA standards (Copper conductors). All other data are provided as supplementary information only. For more details, please consult our CB, UL or CSA certificates and technical datasheet available on <http://www.te.com>

CE	RoHS	ULSR	EAC						

## Accessories

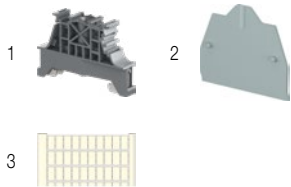

Description	Color	Type	Part Numbers	Pkg qty	Weight (1 pce) g
1 End stops	Grey <input type="checkbox"/>	BAM4	1SNK900001R0000	50	12.00
		BAZ1	1SNK900002R0000	50	4.70
2 End sections	Grey <input type="checkbox"/>	EP5-6	1SNL900100R0000	20	1.6
3 Terminal block markers	White <input type="checkbox"/>	RC610TT	1SNA233600R1700	22	12
		RC610	1SNA233000R0100	10	7.50

Complete list of accessories is indicated in the terminal block datasheet including end stops. Some accessories such as jumper bars may modify the terminal block's ratings: Complete information available in the accessories section of the catalog.

Technical data valid for copper conductors only.

# M4/6.3A.P screw clamp terminal blocks

Ground - 6 mm 0.236 in spacing

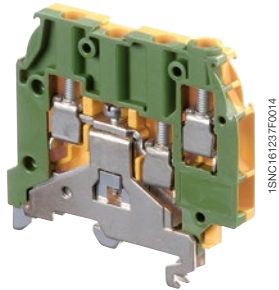
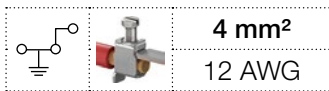

M4/6.3A.P

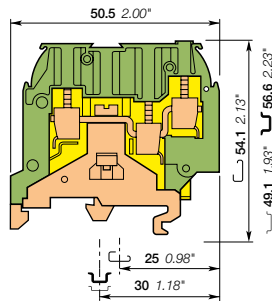

6 mm 0.236 in spacing

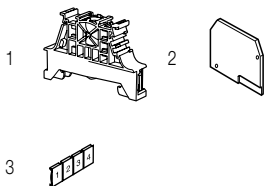

## Description

- Reliable electrical and mechanical contact with the rail,
- Flexibility: snap onto symmetrical and asymmetrical rails.

## Ordering details

Description	Color	Type	Part Number	Pkg qty	Weight (1 pce)
Ground Screw rail connection	Green-yellow	M4/6.3A.P	1SNA195637R1200	50	22.00

## Main technical data

Connecting capacity		IEC	UL	CSA	Mounting instructions	
1 conductor per clamp	Rigid: Solid/Stranded	0.2-4 mm <sup>2</sup>		24-12 AWG	Rail	G32, TH 35-7.5, TH 35-15
	Flexible without ferrule	0.22-4 mm <sup>2</sup>			Wire stripping length	9.5 mm 0.37 in
	Flexible with insulated ferrule				Screw clamp Tool	Flat screwdriver Ø 4 mm Ø 0.16 in
	Gauge	A4			Torque	0.5 - 0.8 N.m 4.4 - 7.1 lb.in
Rated cross section		4 mm <sup>2</sup>		12 AWG	Rail connection screw Tool	Flat screwdriver Ø 4 mm Ø 0.16 in
Rated short-time withstand current (1s)		480 A			Torque	0.8 N.m 7 lb.in

The connecting capacity data for one Rigid: Solid/Stranded, or one Flexible conductor (when applicable) is a mandatory information required by IEC, UL and CSA standards (Copper conductors). All other data are provided as supplementary information only. For more details, please consult our CB, UL or CSA certificates and technical datasheet available on <http://www.te.com>

CE	RoHS	CSA	Goel R				
----	------	-----	--------	--	--	--	--

## Accessories

Description	Color	Type	Part Number	Pkg qty	Weight (1 pce)
1 End stops	Grey	BAM4	1SNK900001R0000	50	12.00
		BAZ1	1SNK900002R0000	50	4.70
2 End sections	Grey	FEM3A	1SNA116576R1500	20	3.30
3 Terminal block markers	White	RC610TT	1SNA233600R1700	22	12
		RC610	1SNA233000R0100	1	7.50

Complete list of accessories is indicated in the terminal block datasheet. Some accessories such as jumper bars may modify the terminal block's ratings: complete information in the accessories catalogue pages.

Technical data valid for copper conductors only.

# M4/6.4A.P screw clamp terminal blocks

Ground - 6 mm 0.236 in spacing

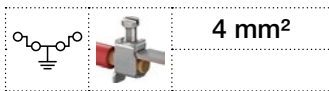

4 mm<sup>2</sup>

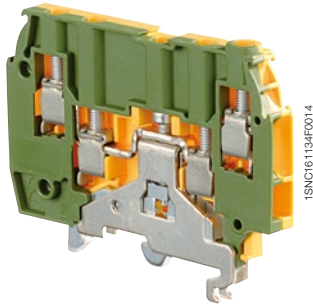

1SNK161134F0014

M4/6.4A.P

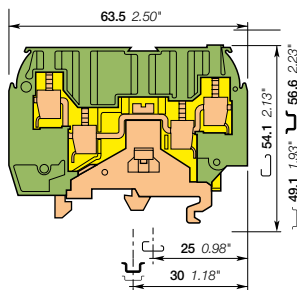

6 mm 0.236 in spacing

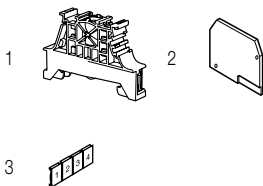

## Description

- Reliable electrical and mechanical contact with the rail,
- Flexibility: snap onto symmetrical and asymmetrical rails.

## Ordering details

Description	Color	Type	Part Number	Pkg qty	Weight (1 pce) g
Ground Screw rail connection	Green-yellow	M4/6.4A.P	1SNA195638R2300	50	22.00

## Main technical data

Connecting capacity		IEC	UL	CSA	Mounting instructions	
1 conductor per clamp	Rigid: Solid/Stranded	0.2-4 mm <sup>2</sup>			Rail	G32, TH 35-7.5, TH 35-15
	Flexible without ferrule	0.22-4 mm <sup>2</sup>			Wire stripping length	9.5 mm 0.37 in
	Flexible with insulated ferrule				Screw clamp Tool	Flat screwdriver Ø 4 mm Ø 0.16 in
	Gauge	A4			Torque	0.5 - 0.8 N.m 4.4 - 7.1 lb.in
Rated cross section		4 mm <sup>2</sup>			Rail connection screw Tool	Flat screwdriver Ø 4 mm Ø 0.16 in
Rated short-time withstand current (1s)		480 A			Torque	0.8 N.m 7 lb.in

The connecting capacity data for one Rigid: Solid/Stranded, or one Flexible conductor (when applicable) is a mandatory information required by IEC, UL and CSA standards (Copper conductors). All other data are provided as supplementary information only. For more details, please consult our CB, UL or CSA certificates and technical datasheet available on <http://www.te.com>

CE	RoHS	Cost R
----	------	--------

## Accessories

Description	Color	Type	Part Number	Pkg qty	Weight (1 pce) g
1 End stops	Grey	BAM4	1SNK900001R0000	50	12.00
		BAZ1	1SNK900002R0000	50	4.70
2 End sections	Grey	FEM4A	1SNA116629R2200	20	3.80
3 Terminal block markers	White	RC610TT	1SNA233600R1700	22	12
		RC610	1SNA233000R0100	1	7.50

Complete list of accessories is indicated in the terminal block datasheet.

Some accessories such as jumper bars may modify the terminal block's ratings: complete information in the accessories catalogue pages.

Technical data valid for copper conductors only.



# C6/8.P screw clamp terminal blocks

Ground - 8 mm 0.31 in spacing



		<b>6 mm<sup>2</sup></b>
		<b>8 AWG</b>

## Description

- Screwless DIN rail contact,
- Reliable electrical and mechanical contact with the rail.

## Ordering details

Description	Color	Type	Part Numbers	Pkg qty	Weight (1 pce)
Ground Screwless DIN rail connection	Green-yellow	C6/8.P	1SNL608150R0000	50	15.2 g

## Main technical data

Connecting capacity		IEC	UL - CSA	Mounting instructions	
<b>1 conductor per clamp</b>	Rigid - Solid / Stranded	0.5 ... 10 mm <sup>2</sup>	20 ... 8 AWG	Rail	TH 35-7.5, TH 35-15
	Flexible	0.5 ... 6 mm <sup>2</sup>	20 ... 8 AWG	Wire stripping length	12 mm 0.47 in
	with non insulated ferrule	0.5 ... 6 mm <sup>2</sup>	20 ... 8 AWG		
	with insulated ferrule	0.5 ... 6 mm <sup>2</sup>	20 ... 10 AWG		
Gauge		A5		Tool	Flat screwdriver Ø 4-5 mm Ø 0.16-0.2 in
<b>Rated cross section</b>		6 mm <sup>2</sup>	8 AWG	Torque	0.9 N.m ± 0.1 8 lb.in ± 0.9
<b>Rated short-time withstand current (1s)</b>		720 A			
<b>Protection</b>		IP20	NEMA 1		

The connecting capacity data for one Rigid - Solid / Stranded - Flexible conductor (when applicable) is a mandatory information required by IEC, UL and CSA standards (Copper conductors). All other data are provided as supplementary information only. For more details, please consult our CB, UL or CSA certificates and technical datasheet available on <http://www.te.com>

CE	RoHS	UL	EAC						



C6/8.P

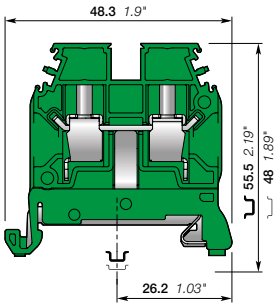

8 mm 0.31 in spacing

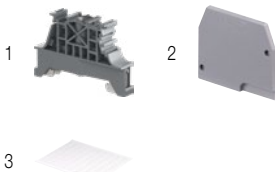

## Accessories

Description	Color	Type	Part Numbers	Pkg qty	Weight (1 pce)
<b>1 End stops</b>	Grey <input type="checkbox"/>	BAM4	1SNK900001R0000	50	12.00
		BAZ1	1SNK900002R0000	50	4.70
<b>2 End sections</b>	Grey <input type="checkbox"/>	FEM6	1SNA118368R1600	20	2.40
<b>3 Terminal block markers</b>	White <input type="checkbox"/>	RC810TT	1SNA234600R1000	22	12
		RC810	1SNA234000R0200	10	8.20

Complete list of accessories is indicated in the terminal block datasheet including end stops. Some accessories such as jumper bars may modify the terminal block's ratings: Complete information available in the accessories section of the catalog.

Technical data valid for copper conductors only.



# C10/10.P screw clamp terminal blocks

Ground - 10 mm 0.39 in spacing

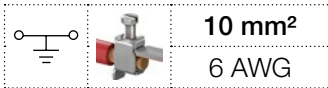

## Description

- Screwless DIN rail contact,
- Reliable electrical and mechanical contact with the rail

## Ordering details

Description	Color	Type	Part Numbers	Pkg qty	Weight (1 pce) g
Ground Screwless DIN rail connection	Green-yellow	C10/10.P	1SNL610150R0000	50	22.5

## Main technical data

Connecting capacity		IEC	UL - CSA	Mounting instructions	
1 conductor per clamp	Rigid - Solid / Stranded	0.5 ... 16 mm <sup>2</sup>	20 ... 6 AWG	Rail	TH 35-7.5, TH 35-15
	Flexible	0.5 ... 10 mm <sup>2</sup>	20 ... 6 AWG	Wire stripping length	12 mm 0.47 in
	with non insulated ferrule	0.5 ... 10 mm <sup>2</sup>	20 ... 6 AWG	Tool	Flat screwdriver Ø 5.5-6 mm Ø 0.22-0.24 in
	with insulated ferrule	0.5 ... 10 mm <sup>2</sup>	20 ... 8 AWG		
Gauge		B6		Torque	1.3 N.m ± 0.1 11.5 lb.in ± 0.9
Rated cross section		10 mm <sup>2</sup>	6 AWG		
Rated short-time withstand current (1s)		1200 A			
Protection		IP20	NEMA 1		

The connecting capacity data for one Rigid - Solid / Stranded - Flexible conductor (when applicable) is a mandatory information required by IEC, UL and CSA standards (Copper conductors). All other data are provided as supplementary information only. For more details, please consult our CB, UL or CSA certificates and technical datasheet available on <http://www.te.com>

CE	RoHS	ULSR	EAC						



C10/10.P

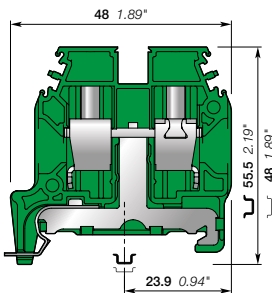

10 mm 0.39 in spacing

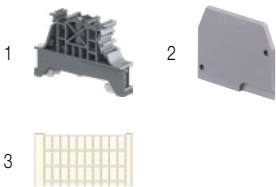

## Accessories

Description	Color	Type	Part Numbers	Pkg qty	Weight (1 pce) g
1 End stops	Grey	BAM4	1SNK900001R0000	50	12.00
		BAZ1	1SNK900002R0000	50	4.70
2 End sections	Grey	FEM6	1SNA118368R1600	20	2.40
3 Terminal block markers	White	RC810TT	1SNA234600R1000	22	12
		RC1010	1SNA238000R1600	10	1.30

Complete list of accessories is indicated in the terminal block datasheet including end stops. Some accessories such as jumper bars may modify the terminal block's ratings: Complete information available in the accessories section of the catalog.

Technical data valid for copper conductors only.

# M16/12.P screw clamp terminal blocks

Ground - 12 mm 0.472 in spacing

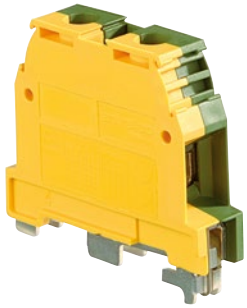

1SN161132P0014

M16/12.P

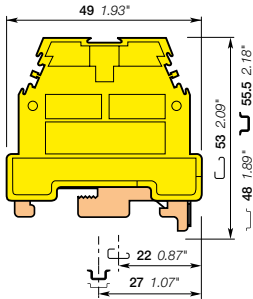

12 mm 0.472 in spacing

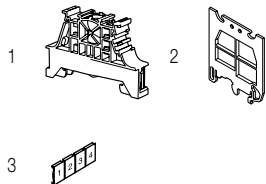

## Description

- Reliable electrical and mechanical contact with the rail,
- Flexibility: snap onto symmetrical and asymmetrical rails.

## Ordering details

Description	Color	Type	Part Number	Pkg qty	Weight (1 pce) <b>g</b>
Ground Screw rail connection	Green-yellow	M16/12.P	1SNA165130R2300	20	40.00

## Main technical data

Connecting capacity		IEC	UL	CSA	Mounting instructions	
1 conductor per clamp	Rigid: Solid/Stranded	2.5-25 mm <sup>2</sup>	14-4 AWG	10-6 AWG	Rail	G32, TH 35-7.5, TH 35-15
	Flexible without ferrule	2.5-16 mm <sup>2</sup>			Wire stripping length	14 mm 0.55 in
	Flexible with insulated ferrule				Screw clamp Tool	Flat screwdriver Ø 5.5 mm Ø 0.22 in
	Gauge	B7			Torque	1.2 - 1.4 N.m 10.6 - 12.4 lb.in
Rated cross section		16 mm <sup>2</sup>	4 AWG	6 AWG	Rail connection screw Tool	Flat screwdriver Ø 5.5 mm Ø 0.22 in
Rated short-time withstand current (1s)		1920 A			Torque	1 N.m 9 lb.in

The connecting capacity data for one Rigid: Solid/Stranded, or one Flexible conductor (when applicable) is a mandatory information required by IEC, UL and CSA standards (Copper conductors). All other data are provided as supplementary information only. For more details, please consult our CB, UL or CSA certificates and technical datasheet available on <http://www.te.com>

CE	RoHS	USR	CSA	Goel R						
----	------	-----	-----	--------	--	--	--	--	--	--

## Accessories

Description	Color	Type	Part Number	Pkg qty	Weight (1 pce) <b>g</b>
1 End stops	Grey	BAM4	1SNK900001R0000	50	12.00
		BAZ1	1SNK900002R0000	50	4.70
2 Circuit separators	Grey	SCFM6	1SNA114825R0500	20	4.00
3 Terminal block markers	White	RC810	1SNA234000R0200	10	8.20
		RC810TT	1SNA234600R1000	22	12
		RC1010	1SNA238000R1600	10	1.30

Complete list of accessories is indicated in the terminal block datasheet. Some accessories such as jumper bars may modify the terminal block's ratings: complete information in the accessories catalogue pages.

Technical data valid for copper conductors only.

# M35/16.P screw clamp terminal blocks

Ground - 16 mm 0.630 in spacing



## Description

- Reliable electrical and mechanical contact with the rail,
- Flexibility: snap onto symmetrical and asymmetrical rails.

## Ordering details

Description	Color	Type	Part Number	Pkg qty	Weight (1 pce)
Ground Screw rail connection	Green-yellow	M35/16.P	1SNA165111R1400	20	50.50

## Main technical data

Connecting capacity	IEC	UL	CSA	Mounting instructions		
1 conductor per clamp	Rigid: Solid/Stranded	6-50 mm <sup>2</sup>	8-0 AWG	6-4 AWG	Rail	G32, TH 35-7.5, TH 35-15
	Flexible without ferrule	6-35 mm <sup>2</sup>			Wire stripping length	17 mm 0.67 in
	Flexible with insulated ferrule				Screw clamp Tool	Flat screwdriver Ø 8 mm Ø 0.32 in
	Gauge	B9			Torque	2.8 - 3 N.m 24.9 - 26.7 lb.in
Rated cross section	35 mm <sup>2</sup>	0 AWG	4 AWG			
Rated short-time withstand current (1s)	4200 A				Rail connection screw Tool	Flat screwdriver Ø 5.5 mm Ø 0.22 in
					Torque	2.8 - 3 N.m 24.9 - 26.7 lb.in

The connecting capacity data for one Rigid: Solid/Stranded, or one Flexible conductor (when applicable) is a mandatory information required by IEC, UL and CSA standards (Copper conductors). All other data are provided as supplementary information only. For more details, please consult our CB, UL or CSA certificates and technical datasheet available on <http://www.te.com>

CE	RoHS	ULR	CSA	Cost R
----	------	-----	-----	--------



M35/16.P

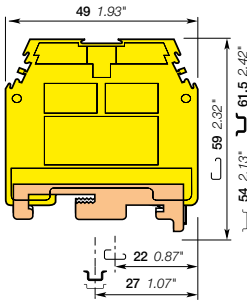

16 mm 0.630 in spacing

## Accessories

Description	Color	Type	Part Number	Pkg qty	Weight (1 pce)
1 End stops	Grey	BAM4	1SNK900001R0000	50	12.00
		BAZ1	1SNK900002R0000	50	4.70
2 Terminal block markers	White	RC810	1SNA234000R0200	10	8.20
		RC810TT	1SNA234600R1000	22	12
		RC1010	1SNA238000R1600	10	1.30

Complete list of accessories is indicated in the terminal block datasheet. Some accessories such as jumper bars may modify the terminal block's ratings: complete information in the accessories catalogue pages.

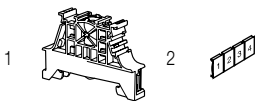

Technical data valid for copper conductors only.

# D70/22.P screw clamp terminal blocks

Ground - 22 mm 0.866 in spacing



1SNK161070F0014

D70/22.P

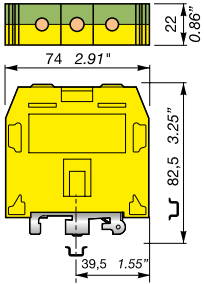

22 mm 0.866 in spacing



## Description

Reliable electrical and mechanical contact with the rail.

## Ordering details

Description	Color	Type	Part Number	Pkg qty	Weight (1 pce) g
Ground Screw rail connection	Green-yellow	D70/22.P	1SNA400772R1300	10	222.00

## Main technical data

Connecting capacity		IEC	UL	CSA	Mounting instructions	
1 conductor per clamp	Rigid: Solid/Stranded	16-95 mm <sup>2</sup>	4-00 AWG	4-00 AWG	Rail	TH 35-15
	Flexible without ferrule	16-70 mm <sup>2</sup>			Wire stripping length	25 mm 0.984 in
	Flexible with insulated ferrule				Screw clamp Tool	Allen key Ø 6 mm Ø 0.236 in
	Gauge	B11			Torque	6 - 7 N.m 53.4 - 62.3 lb.in
Rated cross section		70 mm <sup>2</sup>	00 AWG	00 AWG	Rail connection screw Tool	Allen key Ø 4 mm Ø 0.158 in
Rated short-time withstand current (1s)		8400 A	8088 A	8088 A	Torque	1.8 - 2 N.m 15.9 - 17.7 lb.in

The connecting capacity data for one Rigid: Solid/Stranded, or one Flexible conductor (when applicable) is a mandatory information required by IEC, UL and CSA standards (Copper conductors). All other data are provided as supplementary information only. For more details, please consult our CB, UL or CSA certificates and technical datasheet available on <http://www.te.com>

CE	RoHS	UL	CSA	Gost R															
----	------	----	-----	--------	--	--	--	--	--	--	--	--	--	--	--	--	--	--	--

## Accessories

Description	Color	Type	Part Number	Pkg qty	Weight (1 pce) g
1 End stops 12 mm 0.472 in	Grey	BAZH1	1SNK900102R0000	50	24.00
2 Terminal block markers Blank card	White	RC810TT	1SNA234600R1000	22	12
		RC1010	1SNA238000R1600	1	1.30

Complete list of accessories is indicated in the terminal block datasheet. Some accessories such as jumper bars may modify the terminal block's ratings: complete information in the accessories catalogue pages.

Technical data valid for copper conductors only.

# D95/26.P screw clamp terminal blocks

Ground - 26 mm 1.024 in spacing

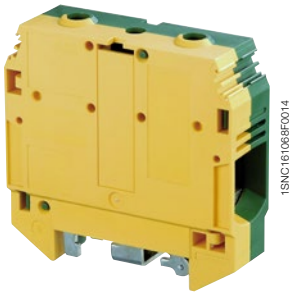

D95/26.P

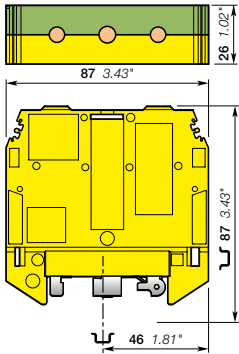

26 mm 1.024 in spacing

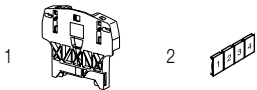

## Description

Reliable electrical and mechanical contact with the rail.

## Ordering details

Description	Color	Type	Part Number	Pkg qty	Weight (1 pce) g
Ground Screw rail connection	Green-yellow	D95/26.P	1SNA400620R1700	10	278.00

## Main technical data

Connecting capacity		IEC	UL	CSA	Mounting instructions	
1 conductor per clamp	Rigid: Solid/Stranded	35-120 mm²	2-0000 AWG	2-0000 AWG	Wire stripping length	26 mm 1.023 in
	Flexible without ferrule	35-95 mm²			Screw clamp Tool	Allen key Ø 6 mm Ø 0.236 in 9 - 9.5 N.m 79.5 - 83.9 lb.in
	Flexible with insulated ferrule				Torque	Allen key Ø 4 mm Ø 0.158 in 1.8 - 2 N.m 15.9 - 17.7 lb.in
Gauge		B12			Rail connection screw Tool	Allen key Ø 4 mm Ø 0.158 in 1.8 - 2 N.m 15.9 - 17.7 lb.in
Rated cross section		95 mm²	0000 AWG	0000 AWG		
Rated short-time withstand current (1s)		11400 A	12840 A	12840 A		

The connecting capacity data for one Rigid: Solid/Stranded, or one Flexible conductor (when applicable) is a mandatory information required by IEC, UL and CSA standards (Copper conductors). All other data are provided as supplementary information only. For more details, please consult our CB, UL or CSA certificates and technical datasheet available on <http://www.te.com>

CE	RoHS	UL	CSA	Gost R															
----	------	----	-----	--------	--	--	--	--	--	--	--	--	--	--	--	--	--	--	--

## Accessories

Description	Color	Type	Part Number	Pkg qty	Weight (1 pce) g
1 End stops	Grey	BAZH1	1SNK900102R0000	50	24.00
2 Terminal block markers	White	RC810TT	1SNA234600R1000	22	12
		RC1010	1SNA238000R1600	1	1.30

Complete list of accessories is indicated in the terminal block datasheet. Some accessories such as jumper bars may modify the terminal block's ratings: complete information in the accessories catalogue pages.

Technical data valid for copper conductors only.

# MA2.5/5.D2 screw clamp terminal blocks

Double deck - 5 mm 0.197 in spacing

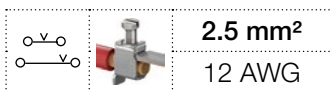

MA2.5/5.D2

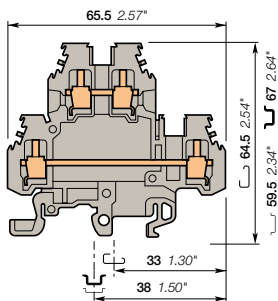

5 mm 0.197 in spacing

## Description

- Save space with double deck terminal blocks: 2 independent circuits connected in just 5 mm 0.197 in spacing,
- Flexibility: snap onto symmetrical and asymmetrical rails.

## Ordering details

Description	Color	Type	Part Number	Pkg qty	Weight (1 pce) g
Feed-through 2 feed-through circuits	Grey	MA2.5/5.D2	1SNA115490R1300	50	15.00
	Blue	MA2.5/5.D2.N	1SNA125490R1500	50	15.00
	Beige	MA2.5/5.D2	1SNA195490R1400	50	15.00

## Main technical data

Connecting capacity	IEC	UL	CSA	Rail	Wire stripping length	Tool	Torque
1 conductor per clamp	Rigid: Solid/Stranded	0.2-4 mm <sup>2</sup>	22-12 AWG	20-12 AWG	9 mm 0.354 in	Flat screwdriver Ø 3.5 mm Ø 0.138 in	0.4 - 0.6 N.m 3.5 - 5.3 lb.in
	Flexible without ferrule	0.22-2.5 mm <sup>2</sup>					
	Flexible with insulated ferrule						
Gauge	A3						
Rated current / Rated cross section	24 A / 2.5 mm <sup>2</sup>	20 A / 12 AWG	25 A / 12 AWG				
Rated short-time withstand current (1s)	300 A						
Rated voltage	630 V	300 V	300 V				
Impulse withstand voltage	8000 V						
Protection	IP20	NEMA 1					

The connecting capacity data for one Rigid: Solid/Stranded, or one Flexible conductor (when applicable) is a mandatory information required by IEC, UL and CSA standards (Copper conductors). All other data are provided as supplementary information only. For more details, please consult our CB, UL or CSA certificates and technical datasheet available on <http://www.te.com>

CE	RoHS	UL	CSA	Gost R															
CE	RoHS	ULR	CSA	Gost R															

## Accessories

Description	Color	Type	Part Number	Pkg qty	Weight (1 pce) g
1 End stops 12 mm 0.472 in	Grey	BAZH1	1SNK900102R0000	50	24.00
2 End sections 1 mm 0.039 in	Grey	FEM6D	1SNA118499R2300	20	2.70
3 Jumper bars 2 poles 24 A		BJMI5D-2	1SNA176736R2100	10	2.00
		BJMI5D-3	1SNA176737R2200	10	3.00
		BJMI5D-4	1SNA176738R0300	10	4.00
		BJMI5D-5	1SNA176739R0400	10	6.00
		BJMI5D-10	1SNA176740R1100	10	12.00
4 Lateral jumper bars 2 poles 30 A	Grey	PC5-2	1SNA113542R1000	10	1.80
		PC5-10	1SNA113544R1200	10	6.00
5 Insulating tips For lateral jumper bars type PC...		EIP	1SNA113550R2400	10	
6 Circuit separators 0 mm 0 in	Grey	SCMA5D	1SNA116720R2100	10	
7 Shield connectors		CBM5D	1SNA173530R2400	50	
8 Inner deck jumper bars		ITV5	1SNA176259R1300	20	2.00
9 Terminal block markers Blank card	White	RC510TT	1SNA231600R1500	22	12.00
		RC510	1SNA231000R0700	10	5.20

Complete list of accessories is indicated in the terminal block datasheet. Some accessories such as jumper bars may modify the terminal block's ratings: complete information in the accessories catalogue pages.

Technical data valid for copper conductors only.

# MA 2.5/5.D1.1 screw clamp terminal blocks

Double deck - 5 mm 0.197 in spacing

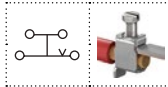

**2.5 mm<sup>2</sup>**  
**12 AWG**

## With vertical interconnection and partition

### Ordering details

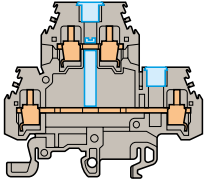

5 mm 0.197 in spacing



Description	Color	Type	Part Number	Pkg qty	Weight (1 pce) g
Feed-through 1 Feed-through circuit with vertical interconnection and partition	Grey <input type="checkbox"/>	MA2.5/5.D1.1	1SNA115530R1200	50	15.00

Main technical data	IEC	UL	CSA	Nota
Rated voltage	630 V		300 V	
Impulse withstand voltage	8000 V			
Protection	IP20	NEMA 1		

--	--	--	--	--	--	--	--	--	--	--	--	--	--	--	--	--	--	--	--

### Accessories

Description	Color	Type	Part Number	Pkg qty	Weight (1 pce) g
1 Test sockets DIA 2 mm 0.079 in		AL2	1SNA164950R0000	50	
2 Test plugs DIA 2 mm 0.079 in	Black <input checked="" type="checkbox"/>	FC2	1SNA007865R2600	100	

Technical data valid for copper conductors only.



# M4/6.D2 screw clamp terminal blocks

Double deck - 6 mm 0.236 in spacing



## Description

- Save space with double deck terminal blocks: 2 independent circuits connected in just 6 mm 0.236 in spacing,
- Flexibility: snap onto symmetrical and asymmetrical rails.

## Ordering details

Description	Color	Type	Part Number	Pkg qty	Weight (1 pce) g
Feed-through 2 feed-through circuits	Grey	M4/6.D2	1SNA115271R2200	50	20.00
	Blue	M4/6.D2.N	1SNA125271R2400	50	20.00
	Orange	M4/6.D2	1SNA105049R0600	50	20.00
	Yellow	M4/6.D2	1SNA105045R2200	50	20.00
	Green	M4/6.D2	1SNA105044R2100	50	20.00
	Red	M4/6.D2	1SNA105048R0500	50	20.00
	White	M4/6.D2	1SNA105046R2300	50	20.00
	Black	M4/6.D2	1SNA105047R2400	50	20.00
	Beige	M4/6.D2	1SNA195271R2300	50	20.00

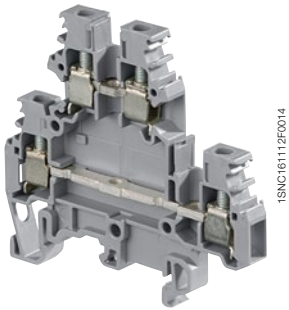

1SNC16112F0014

M4/6.D2

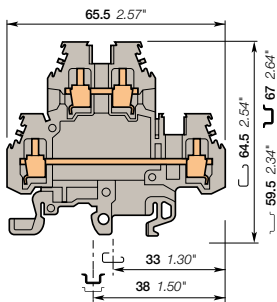

6 mm 0.236 in spacing

## Main technical data

Connecting capacity	IEC	UL	CSA	Mounting instructions		
1 conductor per clamp	Rigid: Solid/Stranded	0.2-4 mm <sup>2</sup>	22-12 AWG	24-10 AWG	Rail	G32, TH 35-7.5, TH 35-15
	Flexible without ferrule	0.22-4 mm <sup>2</sup>			Wire stripping length	8.5 mm 0.33 in
	Flexible with insulated ferrule				Tool	Flat screwdriver Ø 4 mm Ø 0.157 in
Gauge	A4				Torque	0.5 - 0.8 N.m 4.4 - 7.1 lb.in
Rated current / Rated cross section	32 A / 4 mm <sup>2</sup>	20 A / 12 AWG	25 A / 10 AWG			
Rated short-time withstand current (1s)	480 A					
Rated voltage	800 V	300 V	600 V			
Impulse withstand voltage	8000 V					
Protection	IP20	NEMA 1				

The connecting capacity data for one Rigid: Solid/Stranded, or one Flexible conductor (when applicable) is a mandatory information required by IEC, UL and CSA standards (Copper conductors). All other data are provided as supplementary information only. For more details, please consult our CB, UL or CSA certificates and technical datasheet available on <http://www.te.com>

CE	RoHS	USR	CSA	Gost R					
----	------	-----	-----	--------	--	--	--	--	--

## Accessories

Description	Color	Type	Part Number	Pkg qty	Weight (1 pce) g	
1 End stops	Grey	BAZH1	1SNK900102R0000	50	24.00	
2 End sections	Grey	FEM6D	1SNA118499R2300	20	2.70	
3 Jumper bars		2 poles	BJMI6D-2	1SNA179668R2000	10	4.00
		3 poles	BJMI6D-3	1SNA179669R2100	10	6.00
		4 poles	BJMI6D-4	1SNA179670R2600	10	8.00
		5 poles	BJMI6D-5	1SNA179671R1300	10	10.00
		10 poles	BJMI6D-10	1SNA179672R1400	10	20.00
4 Lateral jumper bars		PC61-10	1SNA163311R2200	10	5.00	
5 Cross spacing jumpers		EL6	1SNA173627R2100	10	0.10	
6 Circuit separators	Grey	SCM6D	1SNA113482R0500	10	0.30	
		SCF6D	1SNA118495R1700	20		
7 Shield connectors		CBM5D	1SNA173530R2400	50		
8 Terminal block markers	White	RC610TT	1SNA233600R1700	22	12	
		RC610	1SNA233000R0100	1	7.50	

Complete list of accessories is indicated in the terminal block datasheet. Some accessories such as jumper bars may modify the terminal block's ratings: complete information in the accessories catalogue pages.

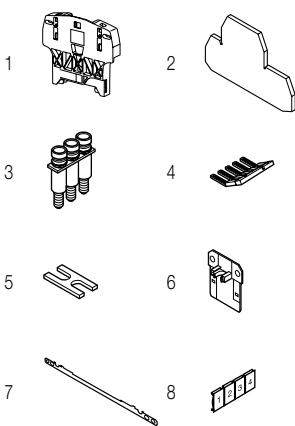

Technical data valid for copper conductors only.



# M4/6.D1 screw clamp terminal blocks

Double deck - 6 mm 0.236 in spacing



**4 mm<sup>2</sup>**  
**10 AWG**

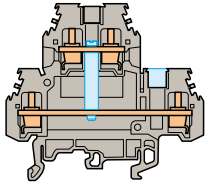

6 mm 0.236 in spacing



## With vertical interconnection and partition

### Ordering details

Description	Color	Type	Part Number	Pkg qty	Weight (1 pce) g
Feed-through 1 feed-through circuit with vertical interconnection and partition	Grey <input type="checkbox"/>	M4/6.D1	1SNA115166R1100	50	20.00
	Blue <input checked="" type="checkbox"/>	M4/6.D1.N	1SNA125166R1300	50	20.00

Main technical data	IEC	UL	CSA	Nota
Rated voltage	800 V		600 V	
Impulse withstand voltage	8000 V			
Protection	IP20	NEMA 1		

 CE	 RoHS	 CSA	 Gost R																	
--	--	---	--	--	--	--	--	--	--	--	--	--	--	--	--	--	--	--	--	--

### Accessories

Description	Color	Type	Part Number	Pkg qty	Weight (1 pce) g
1 Test sockets		AL2	1SNA163070R0000	50	
		AL3	1SNA163261R0000	50	1.20
2 Test plugs	Black <input checked="" type="checkbox"/>	FC2	1SNA007865R2600	100	

Technical data valid for copper conductors only.

# M4/6.DD screw clamp terminal blocks

Component holder - 6 mm 0.236 in spacing

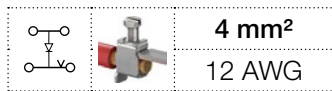

4 mm<sup>2</sup>  
12 AWG



1SNC161208FC014

M4/6.DD

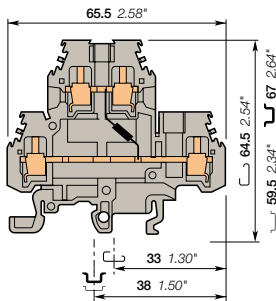

6 mm 0.236 in spacing

## Description

Protect or test your circuit with one 1N4007 diodes.

## Ordering details

Description	Color	Type	Part Number	Pkg	Weight
Component holder	Cathode of the blocking diode connected to the lower circuit	Grey <input type="checkbox"/> M4/6.DD	1SNA115168R2300	pce 50	(1 pce) <b>g</b> 20.00

## Main technical data

		IEC	UL	CSA	Mounting instructions	
1 conductor per clamp	Rigid: Solid/Stranded	0.2-4 mm <sup>2</sup>	22-12 AWG	18-12 AWG	Rail	G32, TH 35-7.5, TH 35-15
	Flexible without ferrule	0.22-4 mm <sup>2</sup>			Wire stripping length	8.5 mm 0.33 in
	Flexible with insulated ferrule				Tool	Flat screwdriver Ø 4 mm Ø 0.157 in
	Gauge				Torque	0.5 - 0.6 Nm 4.4 - 5.3 lb.in
Rated current / Rated cross section		20 A / 4 mm <sup>2</sup>	25 A / 12 AWG	25 A / 12 AWG		
Rated short-time withstand current (1s)		480 A				
Rated voltage		500 V	600 V	150 V		
Impulse withstand voltage						
Protection		IP20	NEMA 1			

The connecting capacity data for one Rigid: Solid/Stranded, or one Flexible conductor (when applicable) is a mandatory information required by IEC, UL and CSA standards (Copper conductors). All other data are provided as supplementary information only. For more details, please consult our CB, UL or CSA certificates and technical datasheet available on <http://www.te.com>



## Typical lamp test application

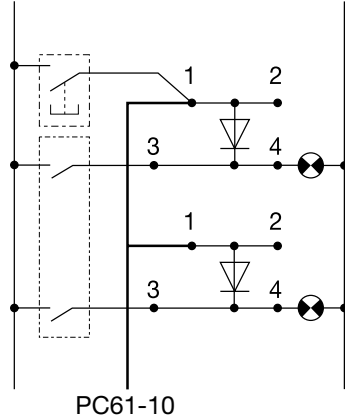

PC61-10

## Accessories

Description	Color	Type	Part Number	Pkg	Weight	
1 End stops	Dark grey <input type="checkbox"/>	BAZH1	1SNK900102R0000	pce 20	(1 pce) <b>g</b> 24.00	
2 End sections	Grey <input type="checkbox"/>	FEM6D	1SNA118499R2300	20	2.70	
3 Jumper bars		2 poles	BJMI6D-2	1SNA179668R2000	10	4.00
		3 poles	BJMI6D-3	1SNA179669R2100	10	6.00
		4 poles	BJMI6D-4	1SNA179670R2600	10	8.00
		5 poles	BJMI6D-5	1SNA179671R1300	10	10.00
		10 poles	BJMI6D-10	1SNA179672R1400	10	20.00
4 Lateral jumper bars		PC61-10	1SNA163311R2200	10	5.00	
5 Cross spacing jumpers		EL6	1SNA173627R2100	10	0.10	
6 Terminal block markers	White <input type="checkbox"/>	Blank card	RC610TT	1SNA233600R1700	22	12
			RC610	1SNA233000R0100	1	7.50

Complete list of accessories is indicated in the terminal block datasheet.

Some accessories such as jumper bars may modify the terminal block's ratings: complete information in the accessories catalogue pages.

Technical data valid for copper conductors only.

# M4/6.DD1 screw clamp terminal blocks

Component holder - 6 mm 0.236 in spacing

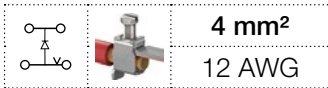

## Description

Protect or test your circuit with one 1N4007 diodes.

## Ordering details

Description	Color	Type	Part Number	Pkg pce	Weight (1 pce) g
Component holder	Grey <input type="checkbox"/>	M4/6.DD1	1SNA115184R0400	50	20.00

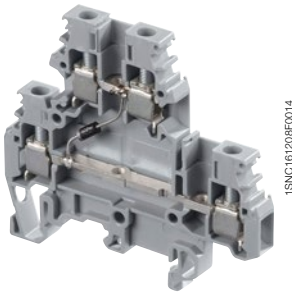

1SNC161208FC0014

M4/6.DD

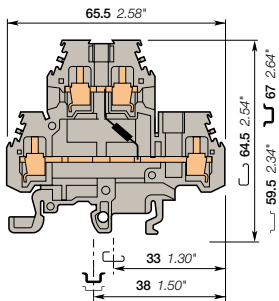

6 mm 0.236 in spacing

## Main technical data

	IEC	UL	CSA	Mounting instructions
<b>1 conductor per clamp</b>	Rigid: Solid/Stranded Flexible without ferrule Flexible with insulated ferrule Gauge	0.2-4 mm <sup>2</sup> 0.22-4 mm <sup>2</sup>	22-12 AWG 18-12 AWG	Rail  G32, TH 35-7.5, TH 35-15 Wire stripping length  8.5 mm 0.33 in Tool  Flat screwdriver Ø 4 mm Ø 0.157 in
<b>Rated current / Rated cross section</b>	20 A / 4 mm <sup>2</sup>	25 A / 12 AWG	25 A / 12 AWG	Torque  0.5 - 0.6 Nm 4.4 - 5.3 lb.in
<b>Rated short-time withstand current (1s)</b>	480 A			
<b>Rated voltage</b>	500 V	600 V	150 V	
<b>Impulse withstand voltage</b>				
<b>Protection</b>	IP20	NEMA 1		

The connecting capacity data for one Rigid: Solid/Stranded, or one Flexible conductor (when applicable) is a mandatory information required by IEC, UL and CSA standards (Copper conductors). All other data are provided as supplementary information only. For more details, please consult our CB, UL or CSA certificates and technical datasheet available on <http://www.te.com>

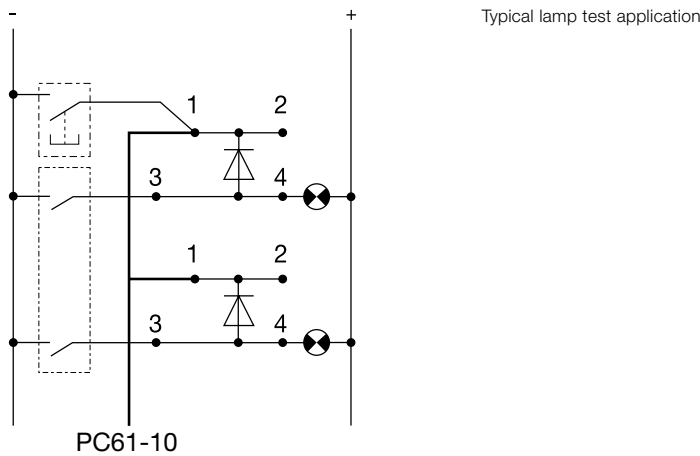

## Accessories

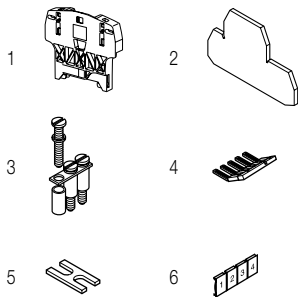

Description	Color	Type	Part Number	Pkg pce	Weight (1 pce) g
1 End stops 10 mm 0.394 in	Dark grey <input type="checkbox"/>	BAZH1	1SNK900102R0000	20	24.00
2 End sections 1 mm 0.039 in	Grey <input type="checkbox"/>	FEM6D	1SNA118499R2300	20	2.70
3 Jumper bars 2 poles 32 A		BJM6D-2	1SNA179668R2000	10	4.00
3 poles		BJM6D-3	1SNA179669R2100	10	6.00
4 poles		BJM6D-4	1SNA179670R2600	10	8.00
5 poles		BJM6D-5	1SNA179671R1300	10	10.00
10 poles		BJM6D-10	1SNA179672R1400	10	20.00
4 Lateral jumper bars 10 poles 35 A		PC61-10	1SNA163311R2200	10	5.00
5 Cross spacing jumpers 5 mm 0.200 in - 6 mm 0.236 in - 8 mm 0.315 in		EL6	1SNA173627R2100	10	0.10
6 Terminal block markers Blank card	White <input type="checkbox"/>	RC610TT	1SNA233600R1700	22	12
		RC610	1SNA233000R0100	1	7.50

Complete list of accessories is indicated in the terminal block datasheet.

Some accessories such as jumper bars may modify the terminal block's ratings: complete information in the accessories catalogue pages.

Technical data valid for copper conductors only.

# M6/8.D2 screw clamp terminal blocks

Double deck - 8 mm 0.315 in spacing



M6/8.D

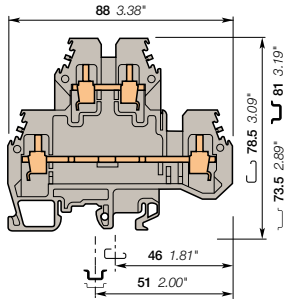

8 mm 0.315 in spacing

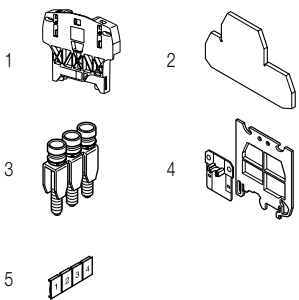

## Description

- Save space with double deck terminal blocks: 2 independent circuits,
- Flexibility: snap onto symmetrical and asymmetrical rails.

## Ordering details

Description	Color	Type	Part Number	Pkg qty	Weight (1 pce)
Feed-through 2 feed-through circuits	Grey <input type="checkbox"/>	M6/8.D2	1SNA115501R1200	50	33.00
	Beige <input type="checkbox"/>	M6/8.D2	1SNA195501R1300	50	33.00

## Main technical data

Connecting capacity		IEC	UL	CSA	Mounting instructions	
1 conductor per clamp	Rigid: Solid/Stranded	0.5-10 mm <sup>2</sup>	18-8 AWG	8 AWG	Rail	G32, TH 35-7.5, TH 35-15
	Flexible without ferrule	0.5-6 mm <sup>2</sup>			Wire stripping length	12 mm 0.47 in
	Flexible with insulated ferrule				Tool	Flat screwdriver Ø 4 - 5 mm Ø 0.157 - 0.197 in
	Gauge	A5			Torque	0.8 - 1 N.m 7.1 - 8.9 lb.in
Rated current / Rated cross section		41 A / 6 mm <sup>2</sup>	50 A / 8 AWG	45 A / 8 AWG		
Rated short-time withstand current (1s)		720 A				
Rated voltage		800 V	600 V	600 V		
Impulse withstand voltage		8000 V				
Protection		IP20	NEMA 1			

The connecting capacity data for one Rigid: Solid/Stranded, or one Flexible conductor (when applicable) is a mandatory information required by IEC, UL and CSA standards (Copper conductors). All other data are provided as supplementary information only. For more details, please consult our CB, UL or CSA certificates and technical datasheet available on <http://www.te.com>

--	--	--	--	--	--	--	--	--	--

## Accessories

Description	Color	Type	Part Number	Pkg qty	Weight (1 pce)
1 End stops 12 mm 0.472 in	Grey <input type="checkbox"/>	BAZH1	1SNK900102R0000	50	24.00
2 End sections 1 mm 0.039 in	Grey <input type="checkbox"/>	FEM8D1	1SNA116656R2500	20	10.00
3 Jumper bars 2 poles 41 A		BJM18-2	1SNA176669R1600	10	4.50
		BJM18-3	1SNA176670R1300	10	6.00
		BJM18-4	1SNA176671R0000	10	10.00
		BJM18-5	1SNA176672R0100	10	12.22
		BJM18-10	1SNA176673R0200	10	20.00
4 Circuit separators 0 mm 0 in	Grey <input type="checkbox"/>	SCM6	1SNA113003R1000	10	0.30
5 Terminal block markers Blank card	White <input type="checkbox"/>	RC810TT	1SNA234600R1000	22	12
		RC810	1SNA234000R0200	1	8.20

Complete list of accessories is indicated in the terminal block datasheet. Some accessories such as jumper bars may modify the terminal block's ratings: complete information in the accessories catalogue pages.

Technical data valid for copper conductors only.

# M6/8.D1 screw clamp terminal blocks

Double deck - 8 mm 0.315 in spacing



**6 mm<sup>2</sup>**  
**8 AWG**

## With vertical interconnection and partition

### Ordering details

Description	Color	Type	Part Number	Pkg qty	Weight (1 pce) g
Feed-through 1 feed-through circuit with vertical interconnection and partition	Grey <input type="checkbox"/>	M6/8.D1	1SNA115498R1700	50	36.00

Main technical data	IEC	UL	CSA	Nota
Rated voltage	800 V	600 V	600 V	
Impulse withstand voltage	8000 V			
Protection	IP20	NEMA 1		

 CE	 RoHS	 USR	 CSA	 Gost R																
--	--	---	---	--	--	--	--	--	--	--	--	--	--	--	--	--	--	--	--	--

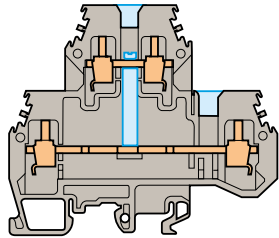

8 mm 0.315 in spacing

### Accessories

Description	Color	Type	Part Number	Pkg qty	Weight (1 pce) g
1 Test sockets		AL2	1SNA163043R2100	50	0.90
		AL3	1SNA163261R0000	50	1.20
2 Test plugs		Black <input checked="" type="checkbox"/> FC2	1SNA007865R2600	100	
		White <input type="checkbox"/> FC4	1SNA167860R0100	10	



Technical data valid for copper conductors only.

# D4/6.T3 screw clamp terminal blocks

Triple deck - 6 mm 0.236 in spacing

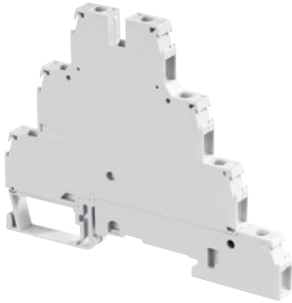

1SNC16107ZF0014

D4/6.T

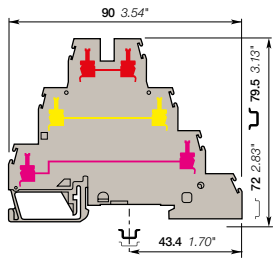

6 mm 0.236 in spacing

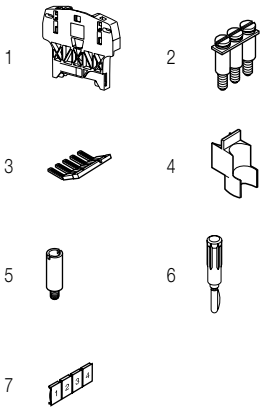

## Description

Save space with triple deck terminal blocks: 3 independent circuits connected in just 6 mm 0.236 in spacing;  
 – closed terminal block: no end section needed, better rigidity.

## Ordering details

Description	Color	Type	Part Number	Pkg qty	Weight (1 pce) g
Feed-through 3 feed-through circuits	Grey <input type="checkbox"/>	D4/6.T3	1SNA299683R0100	25	27.00

## Main technical data

Connecting capacity		IEC	UL	CSA	Mounting instructions	
1 conductor per clamp	Rigid: Solid/Stranded	0.2-4 mm <sup>2</sup>	22-12 AWG		Rail	G32, TH 35-7.5, TH 35-15
	Flexible without ferrule	0.22-4 mm <sup>2</sup>			Wire stripping length	9.5 mm 0.37 in
	Flexible with insulated ferrule				Tool	Flat screwdriver Ø 4 mm Ø 0.16 in
	Gauge	A4			Torque	0.5 - 0.8 N.m 4.4 - 7.1 lb.in
Rated current / Rated cross section		32 A / 4 mm <sup>2</sup>	20 A / 12 AWG			
Rated short-time withstand current (1s)		480 A				
Rated voltage		500 V	300 V			
Impulse withstand voltage		6000 V				
Protection		IP20	NEMA 1			

The connecting capacity data for one Rigid: Solid/Stranded, or one Flexible conductor (when applicable) is a mandatory information required by IEC, UL and CSA standards (Copper conductors). All other data are provided as supplementary information only, for more details, please consult our CB, UL or CSA certificates and technical datasheet available on <http://www.te.com>

CE	RoHS RoHS	UL USR CNR	Gost R					
----	--------------	---------------	--------	--	--	--	--	--

## Accessories

Description	Color	Type	Part Number	Pkg qty	Weight (1 pce) g
1 End stops 12 mm 0.472 in	Grey <input type="checkbox"/>	BAZH1	1SNK900102R0000	50	24.00
2 Jumper bars 2 poles 32 A		BJM62	1SNA173217R2600	10	2.00
			1SNA173218R0700	10	3.00
			1SNA173219R0000	10	4.00
			1SNA173221R2200	10	5.00
			1SNA173226R2700	10	10.00
3 Lateral jumper bars 10 poles 35 A		PC61-10	1SNA163311R2200	10	5.00
4 Circuit separators 1.5 mm 0.059 in	White <input type="checkbox"/>	SCD	1SNA103189R2600	10	1.00
5 Test sockets DIA 2 mm 0.079 in		AL2	1SNA167319R0600	50	
6 Test plugs DIA 2 mm 0.079 in	Black <input checked="" type="checkbox"/>	FC2	1SNA007865R2600	100	
7 Terminal block markers Blank card	White <input type="checkbox"/>	RC65	1SNA232000R0000	1	3.60

Complete list of accessories is indicated in the terminal block datasheet.

Some accessories such as jumper bars may modify the terminal block's ratings: complete information in the accessories catalogue pages.

## With ground, 3 feed-through circuit

### Ordering details

Description	Color	Type	Part Number	Pkg qty	Weight (1 pce) g
Feed-through + 3 feed-through circuits ground + 1 ground	Grey, Green-Yellow	D4/6.T3.P	1SNA299684R0200	25	30.00

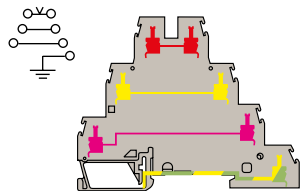

6 mm 0.236 in spacing

Technical data valid for copper conductors only.



# D4/6.T1 screw clamp terminal blocks

Triple deck - 6 mm 0.236 in spacing

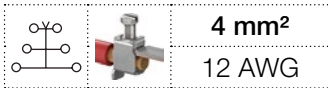

## 1 feed-through circuit

### Ordering details

Description	Color	Type	Part Number	Pkg qty	Weight (1 pce) g
Feed-through 1 feed-through circuit	Black ■	D4/6.T1	1SNA199219R0300	25	29.00

Main technical data	IEC	UL	CSA	Can not be fitted with accessories: test sockets, test plugs and jumper bars BJM62
Rated voltage	500 V	300 V		
Impulse withstand voltage	6000 V			
Protection	IP20	NEMA 1		

CE	RoHS	UL	Gost R																
CE	RoHS	UL	Gost R																

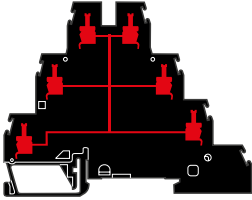

6 mm 0.236 in spacing

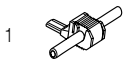

### Accessories

Description	Color	Type	Part Number	Pkg qty	Weight (1 pce) g
1 Jumper bars 1 poles 24 A	Grey ■	AD2.5	1SNA114205R2000	50	1.60

## Ground screw clamp terminal blocks

Description	Color	Type	Part Number	Pkg qty	Weight (1 pce) g
Ground Profile aligned with D4/6.T3...	Green-yellow ■	D4/6.P.T1	1SNA199220R0000	25	

Main technical data	IEC	UL	CSA	Can not be fitted with accessories: test sockets, test plugs and jumper bars BJM62
Rated voltage	500 V	300 V		
Impulse withstand voltage	6000 V			
Protection	IP20	NEMA 1		
Rated short-time withstand current (1s)	480 A			



Technical data valid for copper conductors only.

# MA2.5/5.SNB screw clamp terminal blocks

Disconnect with blade - 5 mm 0.197 in spacing

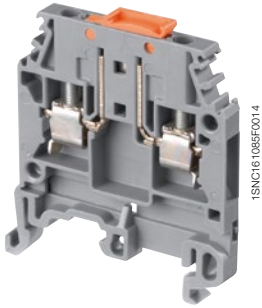

MA2.5/5.SNB

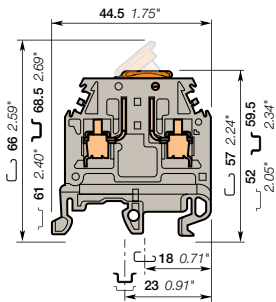

5 mm 0.197 in spacing

## Description

- Ease your disconnect operations with the disconnect blade operated by hand or with screwdriver,
- Same profile as MA2.5/5 feed-through terminal block for aligned marking and identical end section use.

## Ordering details

Description	Color	Type	Part Number	Pkg qty	Weight (1 pce)
Disconnect	Grey-orange	MA2.5/5.SNB	1SNA115699R2000	50	8.00

## Main technical data

Connecting capacity		IEC	UL	CSA	Mounting instructions	
1 conductor per clamp	Rigid: Solid/Stranded	0.5-4 mm <sup>2</sup>		28-12 AWG	Rail	G32, TH 35-7.5, TH 35-15
	Flexible without ferrule	0.5-2.5 mm <sup>2</sup>			Wire stripping length	10 mm 0.39 in
	Flexible with insulated ferrule				Tool	Flat screwdriver Ø 3.5 mm Ø 0.138 in
	Gauge	A3			Torque	0.4 - 0.6 N.m 3.5 - 5.3 lb.in
Rated current / Rated cross section		10 A / 2.5 mm <sup>2</sup>		15 A / 12 AWG		
Rated short-time withstand current (1s)		120 A				
Rated voltage		320 V		600 V		
Impulse withstand voltage		4000 V				
Protection		IP20	NEMA 1			

The connecting capacity data for one Rigid: Solid/Stranded, or one Flexible conductor (when applicable) is a mandatory information required by IEC, UL and CSA standards (Copper conductors). All other data are provided as supplementary information only. For more details, please consult our CB, UL or CSA certificates and technical datasheet available on <http://www.te.com>

CE	RoHS	CCSAus	Gost R			
----	------	--------	--------	--	--	--

## Accessories

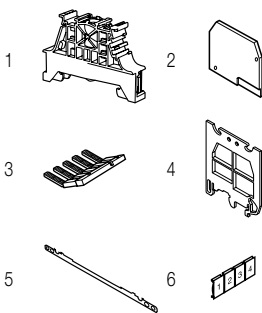

Description	Color	Type	Part Number	Pkg qty	Weight (1 pce)
1 End stops	Grey	BAM4	1SNK900001R0000	50	12.00
		BAZ1	1SNK900002R0000	50	4.70
2 End sections	Grey	FEM6	1SNA118368R1600	20	2.40
3 Lateral jumper bars	Grey	PC5-2	1SNA113542R1000	10	1.80
		PC5-10	1SNA113544R1200	10	6.00
4 Circuit separators	Grey	SCFM6	1SNA114825R0500	20	4.00
		SCF6	1SNA118707R0300	20	
5 Shield connectors		CBM5	1SNA178745R1400	50	
6 Terminal block markers	White	RC510TT	1SNA231600R1500	22	12.00
		RC510	1SNA231000R0700	1	5.20

Complete list of accessories is indicated in the terminal block datasheet. Some accessories such as jumper bars may modify the terminal block's ratings: complete information in the accessories catalogue pages.

Technical data valid for copper conductors only.

# C4/6.S screw clamp terminal blocks

Disconnect with blade - 6 mm 0.24 in spacing

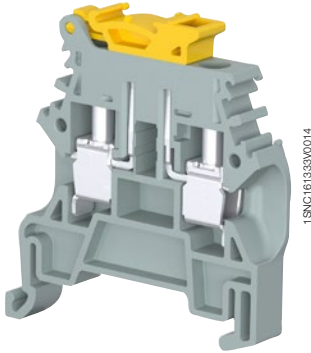
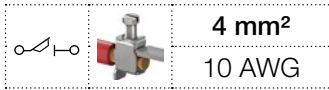

C4/6.S

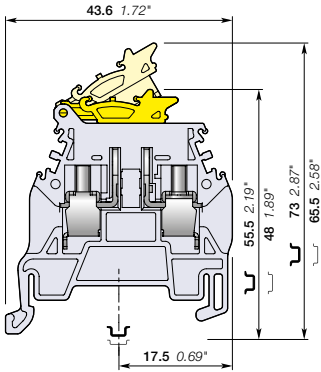

6 mm 0.24 in spacing

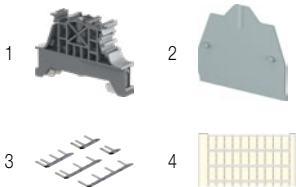

## Description

- Ease your disconnect operations with the disconnect blade operated by hand or with a screwdriver,
- Same profile as C2.5/5 or C4/6 feed through terminal block for aligned marking and wiring.

## Ordering details

Description	Color	Type	Part Numbers	Pkg qty	Weight (1 pce) g
Disconnect Profile aligned with C2.5/5 and C4/6 feed through and ground	Grey <input type="checkbox"/>	C4/6.S	1SNL606310R0000	100	8.7

## Main technical data

Connecting capacity		IEC	UL - CSA	Mounting instructions	
1 conductor per clamp	Rigid - Solid / Stranded	0.2 ... 6 mm <sup>2</sup>	24 ... 10 AWG	Rail	TH 35-7.5, TH 35-15
	Flexible	0.2 ... 4 mm <sup>2</sup>		Wire stripping length	10 mm 0.39 in
	with non insulated ferrule	0.2 ... 4 mm <sup>2</sup>	24 ... 10 AWG		
	with insulated ferrule	0.2 ... 4 mm <sup>2</sup>	24 ... 12 AWG		
	Gauge	A4			
2 conductors per clamp	Rigid - Solid / Stranded	0.2 ... 2.5 mm <sup>2</sup>	24 ... 14 AWG	Tool	Flat screwdriver Ø 4 mm Ø 0.16 in
	Flexible	0.2 ... 2.5 mm <sup>2</sup>	24 ... 16 AWG		
	with twin ferrule	0.2 ... 2.5 mm <sup>2</sup>	24 ... 16 AWG		
Rated current / Rated cross section		24 A / 2.5 mm <sup>2</sup>	25 A / 10 AWG		
Rated short-time withstand current (1s)		300 A		Torque	0.65 N.m ± 0.15 5.75 lb.in ± 1.35
Rated voltage		400 V	300 V		
Impulse withstand voltage		6000 V			
Protection		IP20	NEMA 1		

The connecting capacity data for one Rigid - Solid / Stranded - Flexible conductor (when applicable) is a mandatory information required by IEC, UL and CSA standards (Copper conductors). All other data are provided as supplementary information only. For more details, please consult our CB, UL or CSA certificates and technical datasheet available on <http://www.te.com>

CE	RoHS	USR	EAC

## Accessories

Description	Color	Type	Part Numbers	Pkg qty	Weight (1 pce) g		
1 End stops	Grey <input type="checkbox"/>	BAM4	1SNK900001R0000	50	12.00		
		BAZ1	1SNK900002R0000	50	4.70		
2 End sections	Grey <input type="checkbox"/>	EP5-6	1SNL900100R0000	20	1.6		
3 Lateral jumper bars	Grey <input type="checkbox"/>	2 poles	35 (IEC)	PC6-2	1SNA113546R1400	10	2.00
		3 poles	35 (IEC)	PC6-3	1SNA116536R0500	10	2.00
		4 poles	35 (IEC)	PC6-4	1SNA116537R0600	10	3.00
		10 poles	35 (IEC)	PC6-10	1SNA113548R2600	10	8.00
		25 poles	24 (IEC)	LJB6-25E	1SNL906751R0000	10	17.5
		50 poles	24 (IEC)	LJB6-50	1SNL906750R0000	10	25.5
		4 Terminal block markers	White <input type="checkbox"/>	Blank card	RC610TT	1SNA233600R1700	22
	RC610			1SNA233000R0100	10	7.50	

Complete list of accessories is indicated in the terminal block datasheet including end stops. Some accessories such as jumper bars may modify the terminal block's ratings: Complete information available in the accessories section of the catalog.

Technical data valid for copper conductors only.

# M4/6.SNB screw clamp terminal blocks

Disconnect with blade - 6 mm 0.236 in spacing

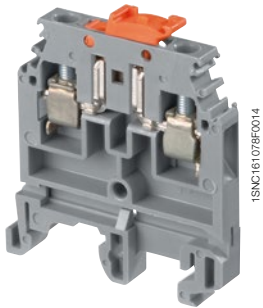
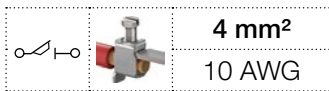

M4/6.SNB

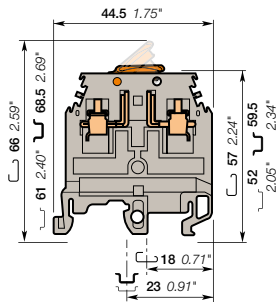

6 mm 0.236 in spacing

## Description

- Ease your disconnect operations with the disconnect blade operated by hand or with screwdriver,
- Same profile as M4/6 feed-through terminal block for aligned marking.

## Ordering details

Description	Color	Type	Part Number	Pkg qty	Weight (1 pce) g
Disconnect	Grey, Orange	M4/6.SNB	1SNA115986R0000	50	11.00
	Orange, Orange	M4/6.SNB	1SNA105053R2200	50	11.00
	Grey, Grey	M4/6.SNB	1SNA115686R1300	50	11.00
	Beige, Grey	M4/6.SNB	1SNA195686R1400	50	11.00

## Main technical data

Connecting capacity		IEC	UL	CSA	Mounting instructions	
1 conductor per clamp	Rigid: Solid/Stranded	0.5-4 mm²	22-10 AWG	24-10 AWG	Rail	G32, TH 35-7.5, TH 35-15
	Flexible without ferrule	0.5-4 mm²			Wire stripping length	9.5 mm / 0.37 in
	Flexible with insulated ferrule				Tool	Flat screwdriver Ø 4 mm / Ø 0.16 in
	Gauge	A4			Torque	0.5 - 0.6 N.m / 4.4 - 5.3 lb.in
<b>Rated current / Rated cross section</b>		20 A / 4 mm²	10 A / 10 AWG	15 A / 10 AWG		
<b>Rated short-time withstand current (1s)</b>		300 A				
<b>Rated voltage</b>		400 V	300 V	600 V		
<b>Impulse withstand voltage</b>		4000 V				
<b>Protection</b>		IP20	NEMA 1			

The connecting capacity data for one Rigid: Solid/Stranded, or one Flexible conductor (when applicable) is a mandatory information required by IEC, UL and CSA standards (Copper conductors). All other data are provided as supplementary information only. For more details, please consult our CB, UL or CSA certificates and technical datasheet available on <http://www.te.com>

--	--	--	--	--	--	--	--	--

## Accessories

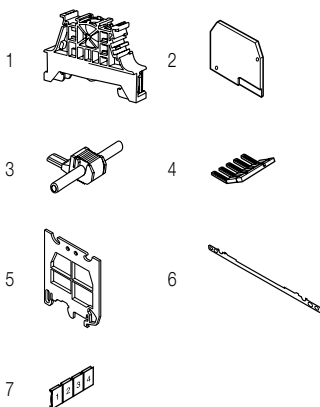

Description	Color	Type	Part Number	Pkg qty	Weight (1 pce) g
1 End stops	Grey	BAM4	1SNK900001R0000	50	12.00
		BAZ1	1SNK900002R0000	50	4.70
2 End sections	Grey	FEM62	1SNA114994R0700	20	2.40
3 Jumper bars	Grey	AD2.5	1SNA114205R2000	50	1.60
4 Lateral jumper bars		PC61-10	1SNA163311R2200	10	5.00
5 Circuit separators	Grey	SCFM6	1SNA114825R0500	20	4.00
6 Shield connectors	White	CBM5	1SNA178745R1400	50	
		RC610TT	1SNA233600R1700	22	12
7 Terminal block markers		RC610	1SNA233000R0100	1	7.50

Complete list of accessories is indicated in the terminal block datasheet.

Some accessories such as jumper bars may modify the terminal block's ratings: complete information in the accessories catalogue pages.

Technical data valid for copper conductors only.

# M6/8.SNB screw clamp terminal blocks

Disconnect with blade - 8 mm 0.315 in spacing

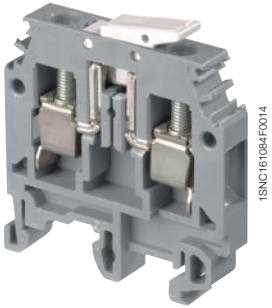
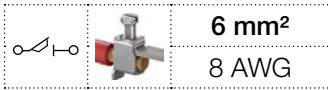

M6/8.SNB

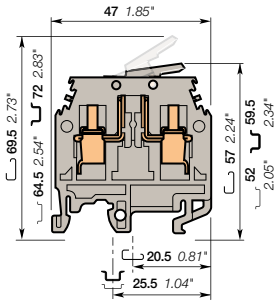

8 mm 0.315 in spacing

## Description

- Ease your disconnect operations with the disconnect blade operated by hand or with screwdriver,
- Same profile as M6/8 feed-through terminal block for aligned marking.

## Ordering details

Description	Color	Type	Part Number	Pkg qty	Weight (1 pce) g
Disconnect	Grey, Grey	M6/8.SNB	1SNA115688R2500	50	19.00
	Orange, Orange	M6/8.SNB	1SNA105055R2400	50	19.00

## Main technical data

Connecting capacity		IEC	UL	CSA
1 conductor per clamp	Rigid: Solid/Stranded	0.5-10 mm <sup>2</sup>	22-8 AWG	22-8 AWG
	Flexible without ferrule	0.5-6 mm <sup>2</sup>		
	Flexible with insulated ferrule			
	Gauge	A5		
Rated current / Rated cross section		15 A / 6 mm <sup>2</sup>	20 A / 8 AWG	20 A / 8 AWG
Rated short-time withstand current (1s)		180 A		
Rated voltage		400 V	300 V	600 V
Impulse withstand voltage		4000 V		
Protection		IP20	NEMA 1	

## Mounting instructions

Rail		G32, TH 35-7.5, TH 35-15
Wire stripping length		12 mm 0.47 in
Tool		Flat screwdriver Ø 4-5 mm Ø 0.16-0.20 in
Torque		0.8 - 1 N.m 7.1 - 8.9 lb.in

The connecting capacity data for one Rigid: Solid/Stranded, or one Flexible conductor (when applicable) is a mandatory information required by IEC, UL and CSA standards (Copper conductors). All other data are provided as supplementary information only. For more details, please consult our CB, UL or CSA certificates and technical datasheet available on <http://www.te.com>

CE	RoHS	USR	cCSAus	Gost R

## Accessories

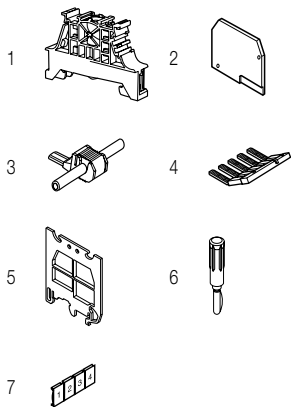

Description	Color	Type	Part Number	Pkg qty	Weight (1 pce) g
1 End stops	Grey	BAM4	1SNK900001R0000	50	12.00
	Grey	BAZ1	1SNK900002R0000	50	4.70
2 End sections	Grey	FEM8	1SNA113373R2600	20	3.00
3 Jumper bars	Grey	AD2.5	1SNA114205R2000	50	1.60
4 Lateral jumper bars		PC8-2	1SNA116538R1700	10	3.00
		PC8-3	1SNA116539R1000	10	4.00
		PC8-4	1SNA116540R2500	10	6.00
		PC8-10	1SNA163313R2400	10	
5 Circuit separators	Grey	SCFM6	1SNA114825R0500	20	4.00
6 Test plugs	Black	FC2	1SNA007865R2600	100	
7 Terminal block markers	White	RC810TT	1SNA234600R1000	22	12
	White	RC810	1SNA234000R0200	1	8.20

Complete list of accessories is indicated in the terminal block datasheet.

Some accessories such as jumper bars may modify the terminal block's ratings: complete information in the accessories catalogue pages.

Technical data valid for copper conductors only.

# M4/6.D2.SNBT screw clamp terminal blocks

Disconnect with blade - with test socket - 6 mm 0.236 in spacing



4 mm<sup>2</sup>  
12 AWG



1SNC161089F0014

M4/6.D2.SNBT

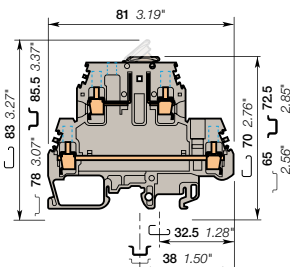

6 mm 0.236 in spacing

## Description

- Save space with double deck terminal blocks: 1 disconnect circuit on top + 1 independent feed-through circuit on bottom in just 6 mm 0.236 in spacing,
- Ease your disconnect operations with the disconnect blade operated by hand or with screwdriver,
- Same profile as M4/6.D2 feed-through terminal block for aligned marking and identical end section use.

## Ordering details

Description	Color	Type	Part Number	Pkg qty	Weight (1 pce)
Disconnect With 4 tests sockets DIA 2 mm 0.079 in	Grey <input type="checkbox"/>	M4/6.D2.SNBT	1SNA115561R1500	50	21.00

## Main technical data

Connecting capacity	IEC	UL	CSA
<b>1 conductor per clamp</b>			
Rigid: Solid/Stranded	0.5-4 mm <sup>2</sup>	24-12 AWG	24-10 AWG
Flexible without ferrule	0.5-4 mm <sup>2</sup>		
Flexible with insulated ferrule			
Gauge	A4		
<b>Rated current / Rated cross section</b>	10 A / 4 mm <sup>2</sup>	20 A / 12 AWG	15 A / 10 AWG
<b>Rated short-time withstand current (1s)</b>	120 A		
<b>Rated voltage</b>	400 V	300 V	600 V
<b>Impulse withstand voltage</b>	4000 V		
<b>Protection</b>	IP20	NEMA 1	

## Mounting instructions

Rail		G32, TH 35-7.5, TH 35-15
Wire stripping length		9.5 mm 0.374 in
Tool		Flat screwdriver Ø 4 mm Ø 0.157 in
Torque		0.5 - 0.6 N.m 4.4 - 5.3 lb.in

The connecting capacity data for one Rigid: Solid/Stranded, or one Flexible conductor (when applicable) is a mandatory information required by IEC, UL and CSA standards (Copper conductors). All other data are provided as supplementary information only, for more details, please consult our CB, UL or CSA certificates and technical datasheet available on <http://www.te.com>



## Accessories

Description	Color	Type	Part Number	Pkg qty	Weight (1 pce)
1 End stops 12 mm 0.472 in	Grey <input type="checkbox"/>	BAZH1	1SNK900102R0000	50	24.00
2 End sections 1 mm 0.039 in	Grey <input type="checkbox"/>	FEMS6D	1SNA116591R0500	20	3.70
3 Jumper bars 2 poles 32 A	Grey <input type="checkbox"/>	BJMI6D-2	1SNA179668R2000	10	4.00
3 poles		BJMI6D-3	1SNA179669R2100	10	6.00
4 poles		BJMI6D-4	1SNA179670R2600	10	8.00
5 poles		BJMI6D-5	1SNA179671R1300	10	10.00
10 poles		BJMI6D-10	1SNA179672R1400	10	20.00
4 Lateral jumper bars 10 poles 35 A		PC61-10	1SNA163311R2200	10	5.00
5 Cross spacing jumpers 5 mm 0.200 in - 6 mm 0.236 in - 8 mm 0.315 in		EL6	1SNA173627R2100	10	0.10
6 Test plugs DIA 2 mm 0.079 in	Black <input checked="" type="checkbox"/>	FC2	1SNA007865R2600	100	
7 Terminal block markers Blank card	White <input type="checkbox"/>	RC610TT	1SNA233600R1700	22	12
		RC610	1SNA233000R0100	1	7.50

Complete list of accessories is indicated in the terminal block datasheet.

Some accessories such as jumper bars may modify the terminal block's ratings: complete information in the accessories catalogue pages.

Technical data valid for copper conductors only.



## SECURE YOUR MEASUREMENT OPERATIONS

The C6/8.ST... test and measurement terminal block benefit from our long experience in the energy applications and from SNACompact features: Compact, performance, common accessories and marking.

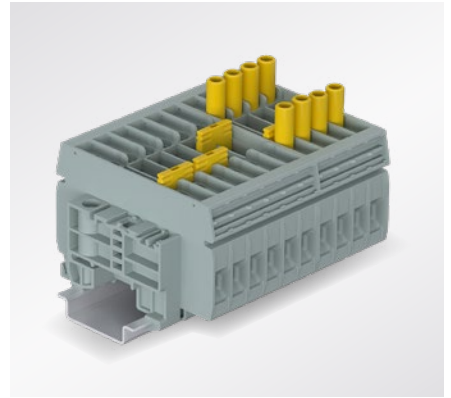

### CONVENIENT AND SECURED DESIGN

- Secured sliding link operated with screwdriver
- Sliding link status – open or close symbols help to visualize the position
- Two built-in test sockets for DIA 4 mm test plug.

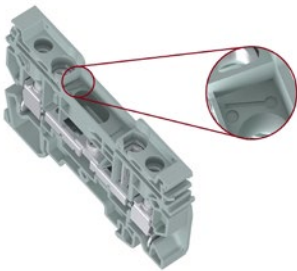

### SHORT-CIRCUIT CT CIRCUITS SAFELY AND CONVENIENTLY

Add the short-circuit bridges accessory (SCB-ST) for your CT's (Current Transformer) application.

- Operated by screwdriver
- Short-circuited position secured by screws Insulated.

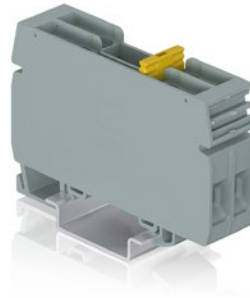

### SAFE MEASUREMENT WITH INSULATED TEST SOCKET

Add the insulated test socket accessory (STI4-Y) for safe measurement.

- Compatible with IP20 test plug DIA 4 mm (IEC 60010-031).

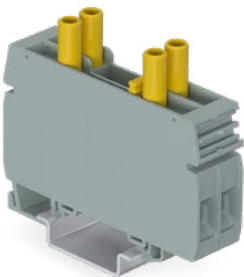

### GUARANTEE ACCESS ONLY TO AUTHORIZED OPERATORS

Compatible with SNK accessories (KCO and CO) to prevent wrong use.

- Cover can be sealed with a cable tie or a seal.

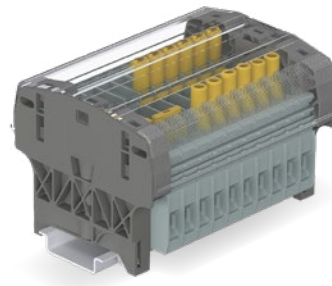

# SNACompact series, terminal blocks

Typical schematics for measuring devices

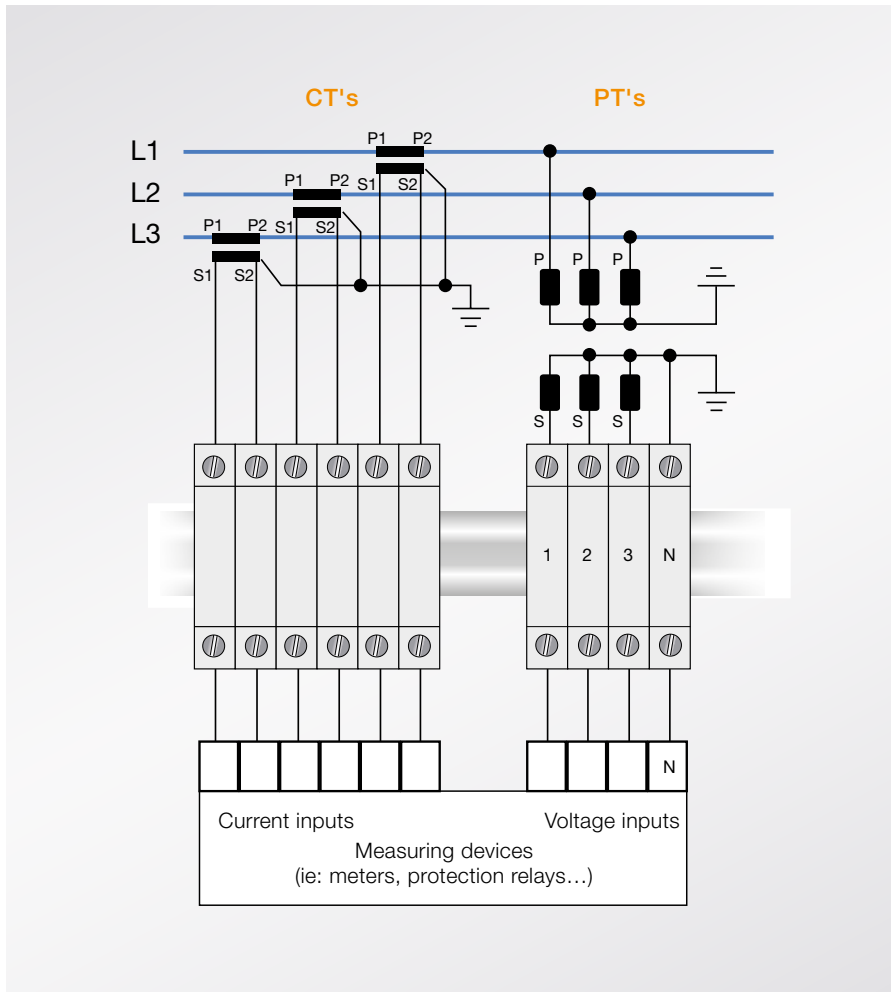

From a basic configuration with disconnect terminal blocks, short-circuit bridges and end sections.

To an IP20 and convenient configuration with the addition of Insulated test sockets, the protecting cover kits and the cover.

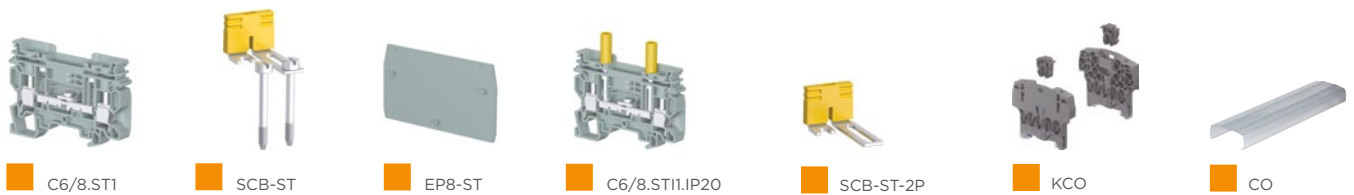
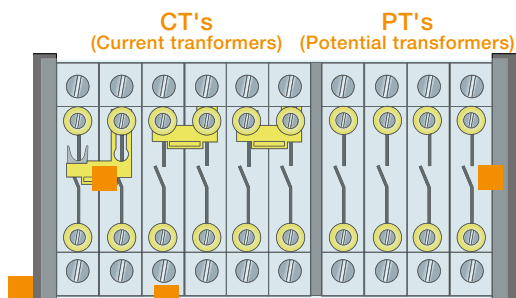
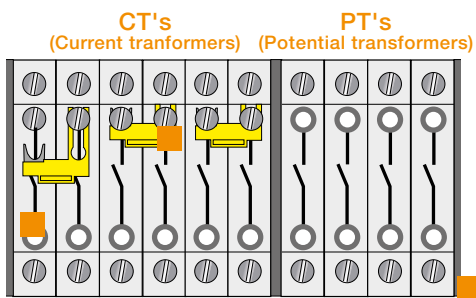

1SNCT160233S0201 - Rev. A

# C6/8.ST1 screw clamp terminal blocks

Disconnect with sliding link - 8 mm 0.31 in spacing

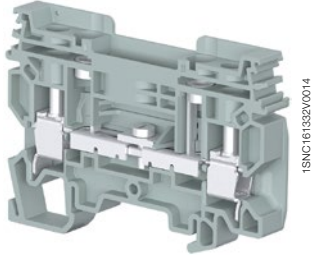
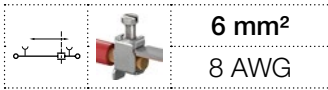

C6/8.ST1

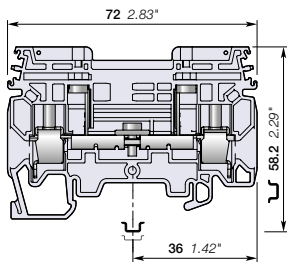

8 mm 0.31 in spacing

## Description

- Secure your disconnect operations in control circuits with the sliding link operated with a screwdriver,
- Includes two built-in test sockets compatible with Dia 4mm 0.157 in test plugs,
- Convenient short-circuit operations with the accessory SCB-ST.

## Ordering details

Description	Color	Type	Part Numbers	Pkg qty	Weight (1 pce) g
Disconnect Two built-in test sockets compatible with Dia 4mm 0.157 in test plugs	Grey <input type="checkbox"/>	C6/8.ST1	1SNL608310R0000	25	21.4

## Main technical data

Connecting capacity		IEC	UL - CSA	Mounting instructions	
1 conductor per clamp	Rigid - Solid / Stranded	0.5 ... 10 mm <sup>2</sup>	20 ... 8 AWG	Rail	TH 35-7.5, TH 35-15
	Flexible	0.5 ... 6 mm <sup>2</sup>		Wire stripping length	12 mm 0.47 in
	with non insulated ferrule	0.5 ... 6 mm <sup>2</sup>	20 ... 8 AWG	Screw clamp Tool	Flat screwdriver Ø 4-5 mm Ø 0.16-0.2 in 0.9 N.m ± 0.1 8 lb.in ± 0.9
	with insulated ferrule	0.5 ... 6 mm <sup>2</sup>	20 ... 10 AWG		
Gauge		A5		Torque	0.9 N.m ± 0.1 8 lb.in ± 0.9
2 conductors per clamp	Rigid - Solid / Stranded	0.5 ... 4 mm <sup>2</sup>	20 ... 12 AWG	Disconnect device Tool	Flat screwdriver Ø 3.5 mm Ø 0.138 in 0.4 ... 0.6 N.m 3.5 ... 5.3 lb.in
	Flexible	0.5 ... 4 mm <sup>2</sup>	20 ... 14 AWG		
with twin ferrule		0.5 ... 4 mm <sup>2</sup>	20 ... 14 AWG	Torque	0.4 ... 0.6 N.m 3.5 ... 5.3 lb.in
Rated current / Rated cross section		40 A / 6 mm <sup>2</sup>	37 A / 8 AWG	Test socket Tool	Flat screwdriver Ø 3.5 mm Ø 0.138 in 0.4 ... 0.6 N.m 3.5 ... 5.3 lb.in
Rated short-time withstand current (1s)		720 A			
Rated voltage		630 V	300 V	Torque	0.4 ... 0.6 N.m 3.5 ... 5.3 lb.in
Impulse withstand voltage		8000 V			
Protection		IP20	NEMA 1		

The connecting capacity data for one Rigid - Solid / Stranded - Flexible conductor (when applicable) is a mandatory information required by IEC, UL and CSA standards (Copper conductors). All other data are provided as supplementary information only. For more details, please consult our CB, UL or CSA certificates and technical datasheet available on <http://www.te.com>

--	--	--	--

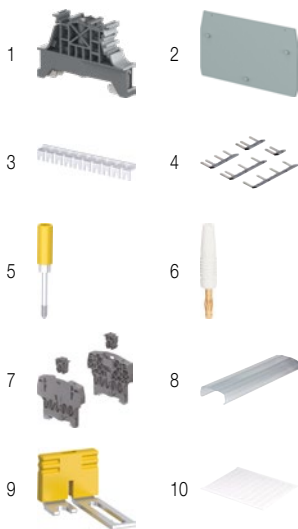

## Accessories

Description	Color	Type	Part Numbers	Pkg qty	Weight (1 pce) g	
1 End stops	Grey <input type="checkbox"/>	BAM4	1SNK900001R0000	50	12.00	
		BAZ1	1SNK900002R0000	50	4.70	
2 End sections	Grey <input type="checkbox"/>	EP8-ST	1SNL900102R0000	10	3.35	
3 Jumper bars		JB-ST-10P	1SNL908310R0000	10	4.03	
4 Lateral jumper bars	Black <input type="checkbox"/>	2 poles	PC8-2	1SNA116538R1700	10	3.00
		10 poles	PC8-10	1SNA163313R2400	10	14.00
		4/6 poles	PC8-R1	1SNA400711R0600	10	6.60
		4/8 poles	PC8-R2	1SNA400712R0700	10	7.80
		4/10 poles	PC8-R3	1SNA400713R0000	10	9.00
		3/4 poles	PC8-R4	1SNA400724R0300	10	4.50
		4/6 poles	PC8-R7	1SNA400849R0000	10	6.60
		4/8 poles	PC8-R8	1SNA400850R0000	10	7.80
		2/3 poles	PC8-R6	1SNA400843R0000	10	6.60
		4/7 poles	PC8-R5	1SNA400842R0000	10	6.60
5 Test sockets	Yellow <input type="checkbox"/>	ST14-YL	1SNL900201R0000	25	6.76	
6 Test plugs	White <input type="checkbox"/>	FC4	1SNA167860R0100	10	10.00	
	Red <input type="checkbox"/>	FC4-1	1SNA167927R1000	10	11.00	
7 Protecting cover kits	Dark grey <input type="checkbox"/>	KCO	1SNK900624R0000	1	47.80	
8 Protecting covers	Transparent <input type="checkbox"/>	CO	1SNK900604R0000	1	300.00	
9 Short circuit bridges	Yellow <input type="checkbox"/>	SCB-ST-2P	1SNL900602R0000	25	2.71	
		SCB-kit	1SNL900902R0000	25	4.81	
10 Terminal block markers	White <input type="checkbox"/>	RC810TT	1SNA234600R1000	22	12	
		RC810	1SNA234000R0200	10	8.20	

Complete list of accessories is indicated in the terminal block datasheet including end stops.

Some accessories such as jumper bars may modify the terminal block's ratings: Complete information available in the accessories section of the catalog.

Technical data valid for copper conductors only.

# C6/8.ST1.IP20 screw clamp terminal blocks

Disconnect with sliding link - 8 mm 0.31 in spacing

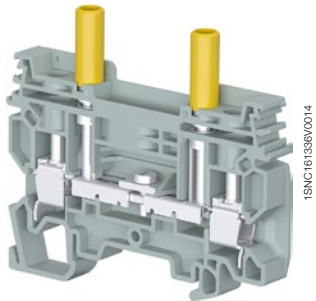
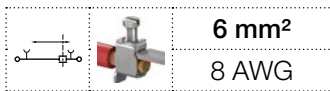

C6/8.ST1.IP20

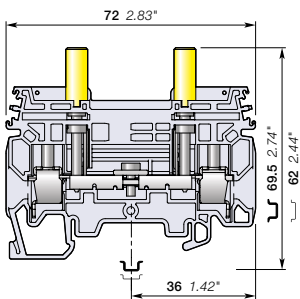

8 mm 0.31 in spacing

## Description

- Secure your disconnect operations in control circuits with the sliding link operated with a screwdriver,
- Includes two built-in test insulated test sockets compatible with IP20 Dia 4mm 0.157 in test plugs,
- Convenient short-circuit operations with the accessory SCB-ST.

## Ordering details

Description	Color	Type	Part Numbers	Pkg qty	Weight (1 pce) g
<b>Disconnect</b> Two insulated test sockets compatible with IP20 Dia 4mm 0.157 in test plugs	Grey <input type="checkbox"/>	C6/8.ST1.IP20	1SNL608311R0000	25	35

## Main technical data

Connecting capacity		IEC	UL - CSA	Mounting instructions	
<b>1 conductor per clamp</b>	Rigid - Solid / Stranded	0.5 ... 10 mm <sup>2</sup>	20 ... 8 AWG	Rail	TH 35-7.5, TH 35-15
	Flexible	0.5 ... 6 mm <sup>2</sup>	20 ... 8 AWG	Wire stripping length	12 mm 0.47 in
	with non insulated ferrule	0.5 ... 6 mm <sup>2</sup>	20 ... 8 AWG	Screw clamp Tool	Flat screwdriver Ø 4-5 mm 0.16-0.2 in 0.9 N.m ± 0.1 8 lb.in ± 0.9
	with insulated ferrule	0.5 ... 6 mm <sup>2</sup>	20 ... 10 AWG		
Gauge		A5		Torque	Flat screwdriver Ø 3.5 mm 0.138 in
<b>2 conductors per clamp</b>	Rigid - Solid / Stranded	0.5 ... 4 mm <sup>2</sup>	20 ... 12 AWG	Disconnect device Tool	Flat screwdriver Ø 3.5 mm 0.138 in
	Flexible	0.5 ... 4 mm <sup>2</sup>	20 ... 14 AWG		
<b>Rated current / Rated cross section</b>		40 A / 6 mm <sup>2</sup>	37 A / 8 AWG	Torque	Flat screwdriver Ø 3.5 mm 0.138 in
<b>Rated short-time withstand current (1s)</b>		720 A			
<b>Rated voltage</b>		630 V	300 V	Torque	Flat screwdriver Ø 3.5 mm 0.138 in
<b>Impulse withstand voltage</b>		8000 V			
<b>Protection</b>		IP20	NEMA 1	Test socket Tool	Flat screwdriver Ø 3.5 mm 0.138 in
				Torque	Flat screwdriver Ø 3.5 mm 0.138 in

The connecting capacity data for one Rigid - Solid / Stranded - Flexible conductor (when applicable) is a mandatory information required by IEC, UL and CSA standards (Copper conductors). All other data are provided as supplementary information only. For more details, please consult our CB, UL or CSA certificates and technical datasheet available on <http://www.te.com>

--	--	--	--

## Accessories

Description	Color	Type	Part Numbers	Pkg qty	Weight (1 pce) g	
<b>1 End stops</b>	Grey <input type="checkbox"/>	BAM4	1SNK900001R0000	50	12.00	
		BAZ1	1SNK900002R0000	50	4.70	
<b>2 End sections</b>	Grey <input type="checkbox"/>	EP8-ST	1SNL900102R0000	10	3.35	
<b>3 Jumper bars</b>		JB-ST-10P	1SNL908310R0000	10	4.03	
<b>4 Lateral jumper bars</b>	Black <input type="checkbox"/>	2 poles	1SNA116538R1700	10	3.00	
		10 poles	PC8-10	1SNA163313R2400	10	14.00
		4/6 poles	PC8-R7	1SNA400849R0000	10	6.60
		4/8 poles	PC8-R8	1SNA400850R0000	10	7.80
		2/3 poles	PC8-R6	1SNA400843R0000	10	6.60
		4/7 poles	PC8-R5	1SNA400842R0000	10	6.60
		4/6 poles	PC8-R1	1SNA400711R0600	10	6.60
		4/8 poles	PC8-R2	1SNA400712R0700	10	7.80
		4/10 poles	PC8-R3	1SNA400713R0000	10	9.00
		3/4 poles	PC8-R4	1SNA400724R0300	10	4.50
<b>5 Test plugs</b>	White <input type="checkbox"/>	DIA 4 mm 0.157 in	FC4	1SNA167860R0100	10	10.00
		DIA 4 mm 0.157 in IP20	FC4-1	1SNA167927R1000	10	11.00
<b>6 Protecting cover kits</b>	Dark grey <input type="checkbox"/>	KCO	1SNK900624R0000	1	47.80	
<b>7 Protecting covers</b>	Transparent <input type="checkbox"/>	CO	1SNK900604R0000	1	300.00	
<b>8 Short circuit bridges</b>	Yellow <input type="checkbox"/>	SCB-ST-2P	1SNL900602R0000	25	2.71	
<b>9 Terminal block markers</b>	White <input type="checkbox"/>	Blank card	RC810TT	22	12	
			RC810	1SNA234000R0200	10	8.20

Complete list of accessories is indicated in the terminal block datasheet including end stops. Some accessories such as jumper bars may modify the terminal block's ratings: Complete information available in the accessories section of the catalog.

Technical data valid for copper conductors only.

# M6/8.ST1 screw clamp terminal blocks

Test disconnect with a screwdriver sliding link - 8 mm 0.315 in spacing

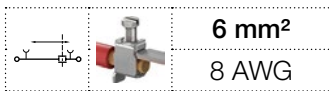

6 mm<sup>2</sup>  
8 AWG

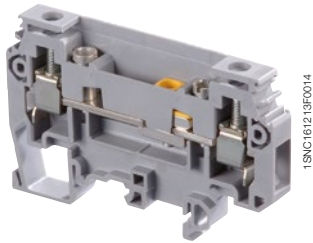

M6/8.ST

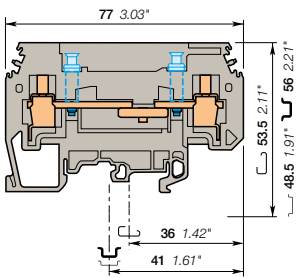

8 mm 0.315 in spacing

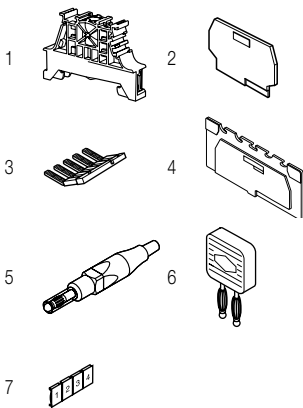

## Description

- Secure your disconnect operations with the disconnect sliding link operated with a screwdriver,
- Ease your test operations with the 2 independent built-in test sockets compatible with DIA 4 mm 0.157 in test plugs.

## Ordering details

Description	Color	Type	Part Number	Pkg pce	Weight (1 pce) g
Disconnect With 2 test sockets DIA 4 mm 0.157 in	Grey <input type="checkbox"/>	M6/8.ST1	1SNA115237R1000	25	30.00

## Main technical data

	IEC	UL	CSA	Mounting instructions
<b>1 conductor per clamp</b>	Rigid: Solid/Stranded Flexible without ferrule Flexible with insulated ferrule Gauge	0.5-10 mm <sup>2</sup> 0.5-6 mm <sup>2</sup> A5	18 - 8 AWG	18-8 AWG
<b>Rated current / Rated cross section</b>	40 A / 6 mm <sup>2</sup>	30 A / 8 AWG	30 A / 8 AWG	
<b>Rated short-time withstand current (1s)</b>	720 A			
<b>Rated voltage</b>	630 V	150 V	150 V	
<b>Impulse withstand voltage</b>				
<b>Protection</b>		NEMA		
				<b>Rail</b> G32, TH 35-7.5, TH 35-15
				<b>Wire stripping length</b> 13 mm 0.51 in
				<b>Screw clamp Tool</b> Flat screwdriver Ø 5 mm Ø 0.197 in
				<b>Torque</b> 0.8 - 1 N.m 7.1 - 8.9 lb.in
				<b>Disconnect device Tool</b> Flat screwdriver Ø 3.5 mm Ø 0.138 in
				<b>Torque</b> 0.4 - 0.6 N.m 3.5 - 5.3 lb.in

The connecting capacity data for one Rigid: Solid/Stranded, or one Flexible conductor (when applicable) is a mandatory information required by IEC, UL and CSA standards (Copper conductors). All other data are provided as supplementary information only. For more details, please consult our CB, UL or CSA certificates and technical datasheet available on <http://www.te.com>

CE	RoHS	ULR	CSA	Gost R

## Accessories

Description	Color	Type	Part Number	Pkg pce	Weight (1 pce) g
1 <b>End stops</b>			BAM4	50	14.00
			BAZ1	50	4.70
2 <b>End sections</b>	Grey <input type="checkbox"/>	FEMT2	1SNA113629R2700	10	2.00
3 <b>Lateral jumper bars 50 A</b>	Black <input type="checkbox"/>	PC8-10	1SNA163313R2400	10	14.00
		PC8-R1	1SNA400711R0600	10	6.60
		PC8-R2	1SNA400712R0700	10	7.84
		PC8-R3	1SNA400713R0000	10	9.00
		PC8-R4	1SNA400724R0300	10	4.50
4 <b>Circuit separators</b>	Grey <input type="checkbox"/>	SCFT2	1SNA114522R0500	20	
5 <b>Test plugs</b>	Red <input type="checkbox"/>	FC4-1	1SNA167927R1000	10	11.00
	Yellow <input type="checkbox"/>	AJS9	1SNA179726R0200	25	3.60
	Black <input type="checkbox"/>	AJS9-BK	1SNA206680R1500	25	3.60
	Green <input type="checkbox"/>	AJS9-GN	1SNA206681R0200	25	3.60
	Grey <input type="checkbox"/>	AJS9-GR	1SNA206682R0300	25	3.60
	Blue <input type="checkbox"/>	AJS9-BL	1SNA206683R0400	25	3.60
	Red <input type="checkbox"/>	AJS9-RD	1SNA206720R1400	25	3.60
	White <input type="checkbox"/>	AJS9-WH	1SNA206765R0000	25	3.60
	Purple <input type="checkbox"/>	AJS9-PR	1SNA206772R0000	25	3.60
	Brown <input type="checkbox"/>	AJS9-BR	1SNA206782R0000	25	3.60
6 <b>Short circuit plugs</b>			BP8.A4	10	3.60
7 <b>Terminal block markers</b>	White <input type="checkbox"/>	RC810TT	1SNA234600R1000	22	12
		RC810	1SNA234000R0200	1	8.20
	Yellow <input type="checkbox"/>	SC-JB8-2	1SNK900652R0000	25	2.00
		SC-JB8-3	1SNK900653R0000	25	3.4
		SC-JB8-4	1SNK900654R0000	25	4.7

Complete list of accessories is indicated in the terminal block datasheet. Same accessories such as jumper bars may modify the terminal block's ratings: complete information in the accessories catalogue pages.

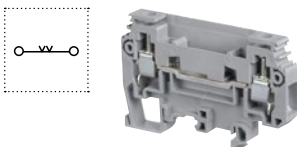

## Feed-through screw clamp terminal blocks

Description	Color	Type	Part Number	Pkg pce	Weight (1 pce) g
Feed-through Profile aligned with M6/8.ST...	Grey <input type="checkbox"/>	M6/8.ST7	1SNA115243R2600	25	20.00

Technical data valid for copper conductors only.



# OPTIMIZE THE PROTECTION AND DISTRIBUTION OF YOUR CONTROL CIRCUIT

Our fuse terminal block complies with the latest evolution of the international standards IEC 60947-7-3 ("Ancillary equipment safety requirements for fuse terminal block") which fixes precise temperature constraint for short-circuit and overload protection.

The fuse holder accepts standard 5 x 20 mm fuses in a compact rotative holder.

### FULLY ALIGNED

The fuse terminal block well aligned with our standard feed-through, disconnect and ground terminal block.

- Ease your installation when wiring and marking
- Ease the potential distribution
- Ease identification with marker on fuse holder and disconnect lever
- Ease your service maintenance with greater accessibility and visibility.

### PERFORMANT BLOWN FUSE INDICATORS

Low leakage current (< 0.5 mA) allows the protection of low current circuits such as PLC's inputs without any risk of circuit disturbances.

Two voltages available (24 V and 250 V).

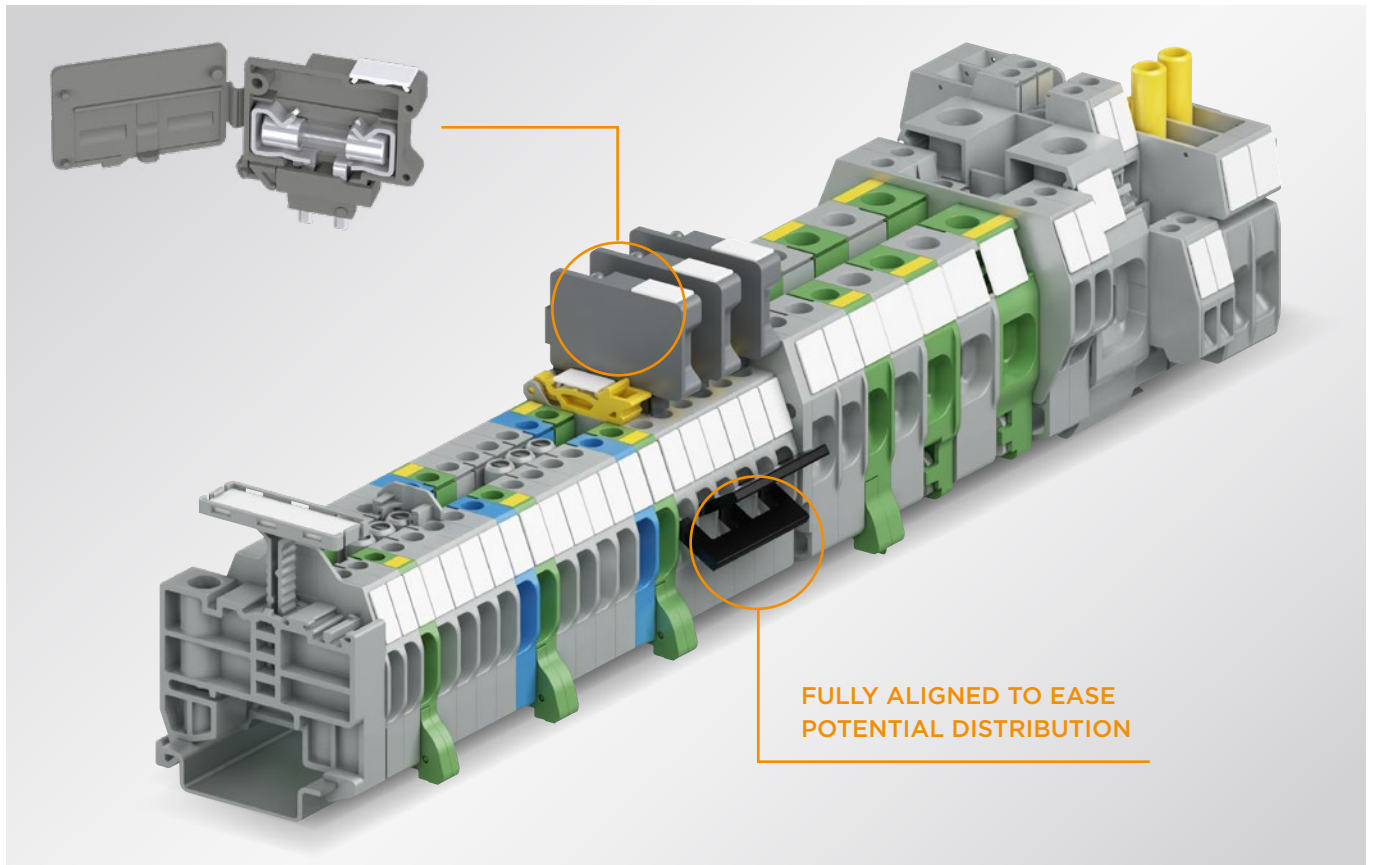



# C4/6.SF screw clamp terminal blocks

Fuse - 6 mm 0.24 in spacing

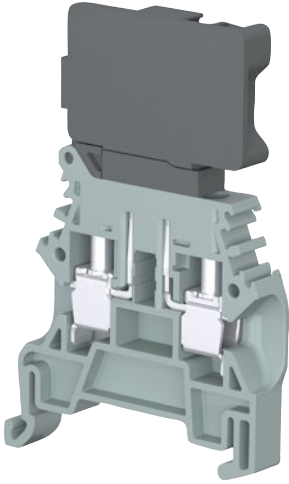
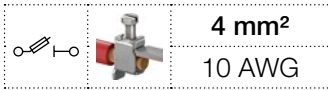

C4/6.SF

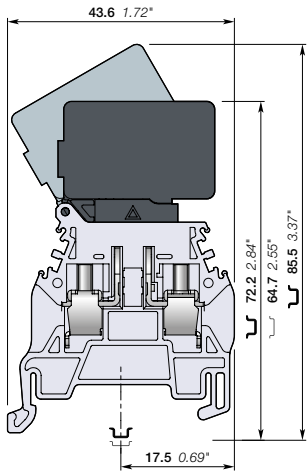

6 mm 0.24 in spacing

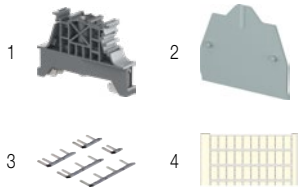

## Description

- Protect your circuits with 5x20 fuse terminal block compliant with IEC 60947-7-3 (fuse not supplied with the terminal blocks),
- Same profile as C2.5/5 or C4/6 feed through terminal block for aligned marking and wiring

## Ordering details

Description	Color	Type	Part Numbers	Pkg qty	Weight (1 pce) g
Fuse Profile aligned with C2.5/5 and C4/6 feed through and ground	Grey, black	C4/6.SF	1SNL606410R0000	50	11.8

## Main technical data

Connecting capacity		IEC	UL - CSA	Mounting instructions	
1 conductor per clamp	Rigid - Solid / Stranded	0.2 ... 6 mm²	24 ... 10 AWG	Rail	TH 35-7.5, TH 35-15
	Flexible	0.2 ... 4 mm²		Wire stripping length	10 mm 0.39 in
	with non insulated ferrule	0.2 ... 4 mm²	24 ... 10 AWG		
	with insulated ferrule	0.2 ... 4 mm²	24 ... 12 AWG		
	Gauge	A4			
2 conductors per clamp	Rigid - Solid / Stranded	0.2 ... 2.5 mm²	24 ... 14 AWG	Tool	Flat screwdriver Ø 4 mm Ø 0.16 in
	Flexible	0.2 ... 2.5 mm²			
	with twin ferrule	0.2 ... 2.5 mm²	24 ... 16 AWG		
Rated current / Rated cross section		6.3 A / 4 mm²	16 A / 10 AWG	Torque	0.65 N.m ± 0.15 5.75 lb.in ± 1.35
Rated voltage		500 V	300 V		
Impulse withstand voltage		6000 V			
Protection		IP20	NEMA 1		

Separate arrangement		Assembly composed of 1 fuse terminal block in between non fuse terminal blocks	Overload and short-circuit protection	2.5 W
			Exclusive short-circuit protection	4 W
Compound arrangement		Assembly composed of 5 fuse terminal blocks	Overload and short-circuit protection	2.5 W
			Exclusive short-circuit protection	4 W

The connecting capacity data for one Rigid - Solid / Stranded - Flexible conductor (when applicable) is a mandatory information required by IEC, UL and CSA standards (Copper conductors). All other data are provided as supplementary information only. For more details, please consult our CB, UL or CSA certificates and technical datasheet available on <http://www.te.com>

CE	RoHS	UR	EAC						
CE	RoHS	UR	EAC						

## Accessories

Description	Color	Type	Part Numbers	Pkg qty	Weight (1 pce) g
1 End stops	Grey	BAM4	1SNK90001R0000	50	12.00
		BAZ1	1SNK90002R0000	50	4.70
2 End sections	Grey	EP5-6	1SNL900100R0000	20	1.6
3 Lateral jumper bars	Grey	PC6-2	1SNA113546R1400	10	2.00
		PC6-3	1SNA116536R0500	10	2.00
		PC6-4	1SNA116537R0600	10	3.00
		PC6-10	1SNA113548R2600	10	8.00
		LJB6-25E	1SNL906751R0000	10	17.5
		LJB6-50	1SNL906750R0000	10	25.5
4 Terminal block markers	White	RC610TT	1SNA233600R1700	22	12
		RC610	1SNA233000R0100	10	7.50

Complete list of accessories is indicated in the terminal block datasheet including end stops. Some accessories such as jumper bars may modify the terminal block's ratings. Complete information available in the accessories section of the catalog.

Technical data valid for copper conductors only.

# C4/6.SFD screw clamp terminal blocks

Fuse - 6 mm 0.24 in spacing

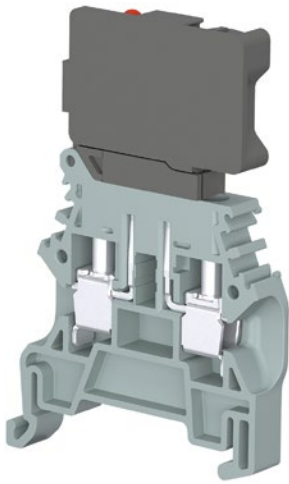

C4/6.SFD

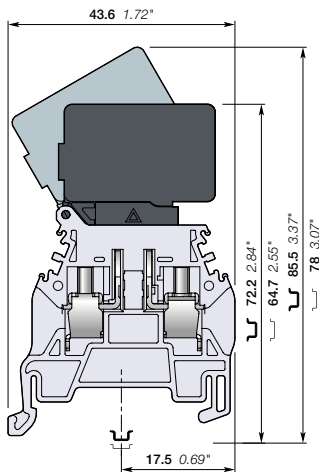

6 mm 0.24 in spacing

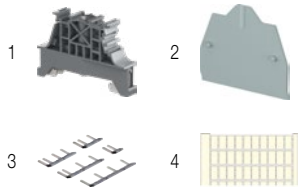

## Description

- Protect your circuits with 5x20 fuse terminal block compliant with IEC 60947-7-3 (fuse not supplied with the terminal blocks),
- Same profile as C2.5/5 or C4/6 feed through terminal block for aligned marking and wiring,
- Quickly identify the defective circuit thanks to the blown fuse indicator (with leakage current <0.5mA).

## Ordering details

Description	Color	Type	Part Numbers	Pkg qty	Weight (1 pce)
Fuse with blown fuse indicator 24 V AC / DC	Grey, black	C4/6.SFD24	1SNL606411R0000	50	12.3
Fuse with blown fuse indicator 250 V AC / DC		C4/6.SFD250	1SNL606412R0000	50	12.3

## Main technical data

Connecting capacity		IEC	UL - CSA	Mounting instructions	
1 conductor per clamp	Rigid - Solid / Stranded	0.2 ... 6 mm <sup>2</sup>	24 ... 10 AWG	Rail	TH 35-7.5, TH 35-15
	Flexible	0.2 ... 4 mm <sup>2</sup>	24 ... 10 AWG	Wire stripping length	10 mm 0.39 in
	with non insulated ferrule	0.2 ... 4 mm <sup>2</sup>	24 ... 10 AWG	Tool	Flat screwdriver Ø 4 mm Ø 0.16 in
	with insulated ferrule	0.2 ... 4 mm <sup>2</sup>	24 ... 12 AWG		
Gauge		A4			
2 conductors per clamp	Rigid - Solid / Stranded	0.2 ... 2.5 mm <sup>2</sup>	24 ... 14 AWG	Torque	0.65 N.m ± 0.15 5.75 lb.in ± 1.35
	Flexible	0.2 ... 2.5 mm <sup>2</sup>	24 ... 16 AWG		
	with twin ferrule	0.2 ... 2.5 mm <sup>2</sup>	24 ... 16 AWG		
Rated current / Rated cross section		6.3 A / 4 mm <sup>2</sup>	16 A / 10 AWG		
Rated voltage		500 V	300 V		
Impulse withstand voltage		6000 V			
Protection		IP20	NEMA 1		

Separate arrangement		Assembly composed of 1 fuse terminal block in between non fuse terminal blocks	Overload and short-circuit protection	2.5 W
			Exclusive short-circuit protection	4 W
Compound arrangement		Assembly composed of 5 fuse terminal blocks	Overload and short-circuit protection	2.5 W
			Exclusive short-circuit protection	4 W

The connecting capacity data for one Rigid - Solid / Stranded - Flexible conductor (when applicable) is a mandatory information required by IEC, UL and CSA standards (Copper conductors). All other data are provided as supplementary information only. For more details, please consult our CB, UL or CSA certificates and technical datasheet available on <http://www.te.com>

CE	RoHS	USR	EAC		
----	------	-----	-----	--	--

## Accessories

Description	Color	Type	Part Numbers	Pkg qty	Weight (1 pce)
1 End stops	Grey	BAM4	1SNK900001R0000	50	12.00
		BAZ1	1SNK900002R0000	50	4.70
2 End sections	Grey	EP5-6	1SNL900100R0000	20	1.6
3 Lateral jumper bars	Grey	PC6-2	1SNA113546R1400	10	2.00
		PC6-3	1SNA116536R0500	10	2.00
		PC6-4	1SNA116537R0600	10	3.00
		PC6-10	1SNA113548R2600	10	8.00
		LJB6-25E	1SNL906751R0000	10	17.5
		LJB6-50	1SNL906750R0000	10	25.5
4 Terminal block markers	White	RC610TT	1SNA233600R1700	22	12
		RC610	1SNA233000R0100	10	7.50

Complete list of accessories is indicated in the terminal block datasheet including end stops. Some accessories such as jumper bars may modify the terminal block's ratings: Complete information available in the accessories section of the catalog.

Technical data valid for copper conductors only.

# C4/8.SF screw clamp terminal blocks

For 5 x 20 and 5 x 25 fuses - 8 mm 0.315 in spacing

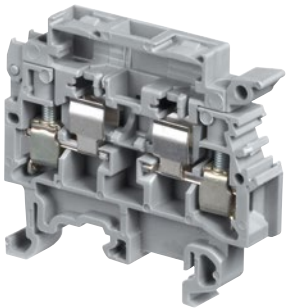

C4/8.SF

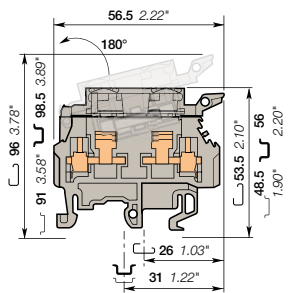

8 mm 0.315 in spacing

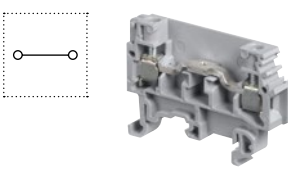
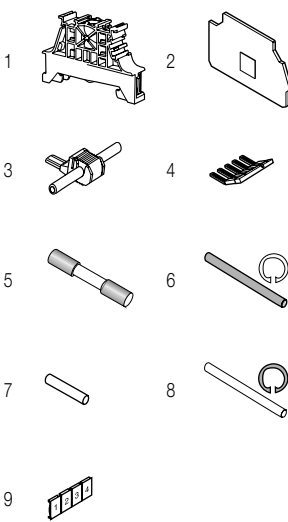

## Description

Protect your circuits with 5x20 and 5x25 fuse terminal blocks (fuse not supplied with terminal blocks).

## Ordering details

Description	Color	Type	Part Number	Pkg qty	Weight (1 pce) g
Fuse	Grey <input type="checkbox"/>	C4/8.SF	1SNL608410R0000	50	14.00

## Main technical data

Connecting capacity	IEC	UL	CSA
1 conductor per clamp	Rigid: Solid/Stranded	0.5-6 mm <sup>2</sup>	22-12 AWG
	Flexible without ferrule	0.5-4 mm <sup>2</sup>	24-12 AWG
	Flexible with insulated ferrule		
	Gauge	A4	
Rated current / Rated cross section	6.3 A / 4 mm <sup>2</sup>	15 A / 12 AWG	10 A / 12 AWG
Rated short-time withstand current (1s)			
Rated voltage	630 V	600 V	250 V
Impulse withstand voltage	8000 V		
Protection	IP20	NEMA 1	

## Mounting instructions

Rail		G32, TH 35-7.5, TH 35-15
Wire stripping length		9.5 mm 0.37 in
Tool		Flat screwdriver Ø 4 mm Ø 0.157 in
Torque		0.5 - 0.8 N.m 4.4 - 7.1 lb.in

The connecting capacity data for one Rigid: Solid/Stranded, or one Flexible conductor (when applicable) is a mandatory information required by IEC, UL and CSA standards (Copper conductors). All other data are provided as supplementary information only. For more details, please consult our CB, UL or CSA certificates and technical datasheet available on <http://www.te.com>

CE	RoHS	UR	CSA	Gost R

## Accessories

Description	Color	Type	Part Number	Pkg qty	Weight (1 pce) g
1 End stops	Grey <input type="checkbox"/>	BAM4	1SNK900001R0000	50	12.00
			BAZ1	1SNK900002R0000	50
2 End sections	Grey <input type="checkbox"/>	FEM8S	1SNA116951R1500	20	2.60
3 Jumper bars	Grey <input type="checkbox"/>	AD2.5	1SNA114205R2000	50	1.60
4 Lateral jumper bars	Grey <input type="checkbox"/>	PC81-10	1SNA173523R1100	10	5.00
			1SNA008288R1500	10	
			1SNA008289R1600	10	
			1SNA008290R1300	10	
			1SNA008291R0000	10	
5 Fuses	Grey <input type="checkbox"/>	FU520	1SNA008292R0100	10	
			0.5 A		
			3.15 A		
			1 A		
6 Assembly rods	Grey <input type="checkbox"/>	TGA8	1SNA168672R1100	10	1.00
			1SNA168673R1200	10	
			1SNA168674R1300	10	
			1SNA179371R1600	10	
7 Neutral cartridges	Grey <input type="checkbox"/>	CN5	1SNA168675R1400	10	3.90
8 Spring retaining rings	Grey <input type="checkbox"/>	ANT	1SNA168675R1400	10	
9 Terminal block markers	White <input type="checkbox"/>	RC810TT	1SNA234600R1000	22	12
			RC810	1SNA234000R0200	10

Complete list of accessories is indicated in the terminal block datasheet. Some accessories such as jumper bars may modify the terminal block's ratings: complete information in the accessories catalogue pages.

## Feed-through screw clamp terminal blocks

Description	Color	Type	Part Number	Pkg qty	Weight (1 pce) g
Feed-through	Grey <input type="checkbox"/>	M4/8	1SNA115523R0700	50	11.00

Technical data valid for copper conductors only.

# M4/8.SFD3 screw clamp terminal blocks

For 5x20 and 5x25 fuses - With blown fuse indicator - 8 mm 0.315 in spacing



4 mm<sup>2</sup>



M4/8.SF

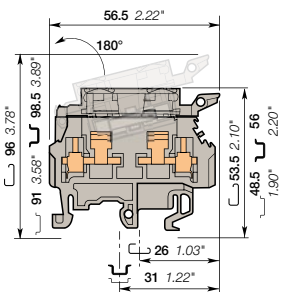

8 mm 0.315 in spacing

## Description

- Protect your circuits with 5x20 and 5x25 fuse terminal blocks (fuse not supplied with terminal blocks),
- Quickly identify the defective circuit thanks to the blown fuse indicator.

## Ordering details

Description	Color	Type	Part Number	Pkg qty	Weight (1 pce)
Fuse With blown fuse indicator by LED 24-60 V DC/ 110 V AC	Grey <input type="checkbox"/>	M4/8.SFD3	1SNA115935R0400	50	14.00

## Main technical data

Connecting capacity	IEC	UL	CSA	Mounting instructions
1 conductor per clamp	Rigid: Solid/Stranded Flexible without ferrule Flexible with insulated ferrule Gauge	0.5-6 mm <sup>2</sup> 0.5-4 mm <sup>2</sup> A4		Rail  G32, TH 35-7.5, TH 35-15 Wire stripping length  9.5 mm 0.374 in Tool  Flat screwdriver Ø 4 mm Ø 0.157 in Torque  0.5 - 0.8 N.m 4.4 - 7.1 lb.in
Rated current / Rated cross section	6.3 A / 4 mm <sup>2</sup>			
Rated short-time withstand current (1s)				
Rated voltage	400 V			
Impulse withstand voltage	4000 V			
Protection	IP20	NEMA 1		

The connecting capacity data for one Rigid: Solid/Stranded, or one Flexible conductor (when applicable) is a mandatory information required by IEC, UL and CSA standards (Copper conductors). All other data are provided as supplementary information only. For more details, please consult our CB, UL or CSA certificates and technical datasheet available on <http://www.te.com>

--	--	--

## Notes

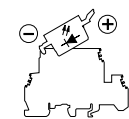

Blocks with LED indicator are labeled "+" on the outside of the lever. The indicator can be reversed in the field if required.  
Leakage current: 24 V: < 0.5 mA / 110 V: < 2.2 mA

## Accessories

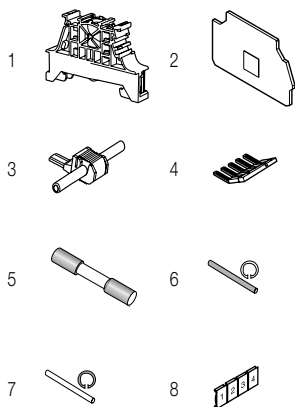

Description	Color	Type	Part Number	Pkg qty	Weight (1 pce)
1 End stops	Grey <input type="checkbox"/>	BAM4	1SNK900001R0000	50	12.00
		BAZ1	1SNK900002R0000	50	4.70
2 End sections	Grey <input type="checkbox"/>	FEM8S	1SNA116951R1500	20	2.60
3 Jumper bars	Grey <input type="checkbox"/>	AD2.5	1SNA114205R2000	50	1.60
4 Lateral jumper bars		PC81-10	1SNA173523R1100	10	5.00
5 Fuses		FU520	1SNA008288R1500	10	
			1SNA008289R1600	10	
			1SNA008290R1300	10	
			1SNA008291R0000	10	
			1SNA008292R0100	10	
6 Assembly rods		TGA8	1SNA168672R1100	10	1.00
			1SNA168673R1200	10	
			1SNA168674R1300	10	
7 Spring retaining rings		ANT	1SNA168675R1400	10	
8 Terminal block markers	White <input type="checkbox"/>	RC810TT	1SNA234600R1000	22	12
		RC810	1SNA234000R0200	1	8.20

Complete list of accessories is indicated in the terminal block datasheet.  
Some accessories such as jumper bars may modify the terminal block's ratings: complete information in the accessories catalogue pages.

Technical data valid for copper conductors only.

# M4/8.SF screw clamp terminal blocks

For 5x20 and 5x25 fuses - With blown fuse indicator - 8 mm 0.315 in spacing

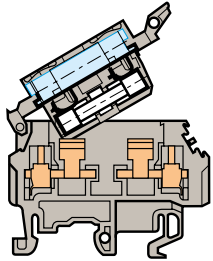
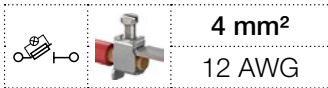

8 mm 0.315 in spacing

## With blown fuse indicator

### Ordering details

Description	Color	Type	Part Number	Pkg qty	Weight (1 pce) g
Fuse With blown fuse indicator by neon 110-230 V AC	Grey <input type="checkbox"/>	M4/8.SFL	1SNA115661R2100	50	14.00
With blown fuse indicator by LED 24 V AC/DC	Grey <input type="checkbox"/>	M4/8.SFD	1SNA115663R2300	50	14.00

Main technical data	IEC	UL	CSA	Leakage current:
Rated voltage	400 V	600 V	250 V	24 V : < 4.5 mA
Impulse withstand voltage	4000 V			110 V : < 0.5 mA
Protection	IP20	NEMA 1		230 V : < 0.7 mA

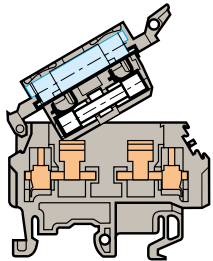
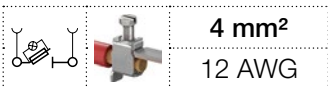

8 mm 0.315 in spacing

## With blown fuse indicator and 2 test socket DIA 2 mm 0.079 in

### Ordering details

Description	Color	Type	Part Number	Pkg qty	Weight (1 pce) g
Fuse With blown fuse indicator by LED 24 V AC/DC and 2 test socket DIA 2 mm 0.079 in	Grey <input type="checkbox"/>	M4/8.SFDT	1SNA115665R2500	50	14.00
With blown fuse indicator by neon 110-230 V AC and 2 test socket DIA 2 mm 0.079 in	Grey <input type="checkbox"/>	M4/8.SFLT	1SNA115667R2700	50	14.00

Main technical data	IEC	UL	CSA	Leakage current:
Rated voltage	400 V	600 V	250 V	24 V : < 4.5 mA
Impulse withstand voltage	4000 V			110 V : < 0.5 mA
Protection	IP20	NEMA 1		230 V : < 0.7 mA



### Accessories

Description	Color	Type	Part Number	Pkg qty	Weight (1 pce) g
1 Test plugs DIA 2 mm 0.079 in	Black <input checked="" type="checkbox"/>	FC2	1SNA007865R2600	100	



1

Technical data valid for copper conductors only.



# M4/8.D2.SF screw clamp terminal blocks

For 5 x 20 and 5 x 25 fuses - 8 mm 0.315 in spacing

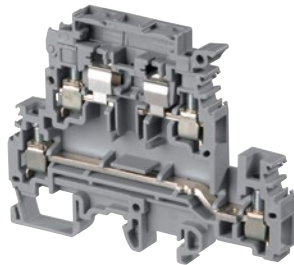
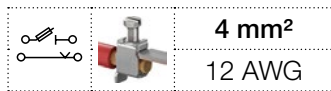

M4/8.D2.SF

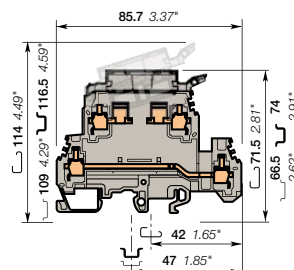

8 mm 0.315 in spacing

## Description

- Protect your circuits with 5x20 and 5x25 fuse terminal blocks (fuse not supplied with terminal blocks),
- Save space with double deck terminal blocks: 2 independent circuits 1 fuse on upper deck + 1 feed-through.

## Ordering details

Description	Color	Type	Part Number	Pkg qty	Weight (1 pce)
Fuse	Grey <input type="checkbox"/>	M4/8.D2.SF	1SNA115604R2100	50	26.00

## Main technical data

Connecting capacity		IEC	UL	CSA	Mounting instructions	
1 conductor per clamp	Rigid: Solid/Stranded	0.5-6 mm <sup>2</sup>	24-12 AWG	24-12 AWG	Rail	G32, TH 35-7.5, TH 35-15
	Flexible without ferrule	0.5-4 mm <sup>2</sup>			Wire stripping length	9.5 mm 0.37 in
	Flexible with insulated ferrule				Tool	Flat screwdriver Ø 4 mm Ø 0.157 in
	Gauge	A4			Torque	0.5 - 0.8 N.m 4.4 - 7.1 lb.in
Rated current / Rated cross section		6.3 A / 4 mm <sup>2</sup>	20 A / 12 AWG	10 A / 12 AWG		
Rated short-time withstand current (1s)						
Rated voltage		630 V	300 V	250 V		
Impulse withstand voltage		8000 V				
Protection		IP20	NEMA 1			

The connecting capacity data for one Rigid: Solid/Stranded, or one Flexible conductor (when applicable) is a mandatory information required by IEC, UL and CSA standards (Copper conductors). All other data are provided as supplementary information only. For more details, please consult our CB, UL or CSA certificates and technical datasheet available on <http://www.te.com>

CE	RoHS	UL	CSA	Gost R
CE	RoHS	UL	CSA	Gost R

## Accessories

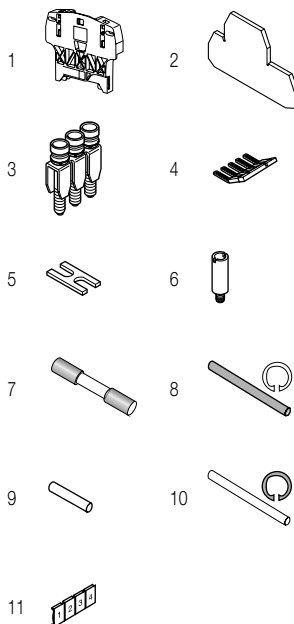

Description	Color	Type	Part Number	Pkg qty	Weight (1 pce)	
1 End stops	Grey <input type="checkbox"/>	BAZH1	1SNK900102R0000	50	24.00	
2 End sections	Grey <input type="checkbox"/>	FEM8D2S	1SNA116913R0700	20	10.00	
3 Jumper bars		2 poles	BJMI8-2	1SNA176669R1600	10	4.50
		3 poles	BJMI8-3	1SNA176670R1300	10	6.00
		4 poles	BJMI8-4	1SNA176671R0000	10	10.00
		10 poles	BJMI8-10	1SNA176673R0200	10	20.00
4 Lateral jumper bars		10 poles	PC81-10	1SNA173523R1100	10	5.00
5 Cross spacing jumpers		5 mm 0.200 in - 6 mm 0.236 in - 8 mm 0.315 in	EL6	1SNA173627R2100	10	0.10
6 Test sockets		DIA 2 mm 0.079 in	AL2	1SNA163043R2100	50	0.90
		DIA 3 mm 0.120 in	AL3	1SNA163261R0000	50	1.20
		DIA 4 mm 0.157 in	AL4-M3	1SNA206721R0100	50	1.10
7 Fuses		0.5 A	FU520	1SNA008288R1500	10	
		1 A		1SNA008290R1300	10	
		2 A		1SNA008291R0000	10	
		4 poles		1SNA168674R1300	10	
8 Assembly rods		2 poles	TGA8	1SNA168672R1100	10	1.00
		3 poles		1SNA168673R1200	10	
		4 poles		1SNA168674R1300	10	
		Neutral cartridges		CN5	1SNA179371R1600	10
10 Spring retaining rings		ANT	1SNA168675R1400	10		
11 Terminal block markers	White <input type="checkbox"/>	RC810TT	1SNA234600R1000	22	12	
		RC810	1SNA234000R0200	1	8.20	

Complete list of accessories is indicated in the terminal block datasheet. Some accessories such as jumper bars may modify the terminal block's ratings: complete information in the accessories catalogue pages.

Technical data valid for copper conductors only.



## M4/8.D2.SF screw clamp terminal blocks

For 5 x 20 and 5 x 25 fuses - with blown fuse indicator - 8 mm 0.315 in spacing

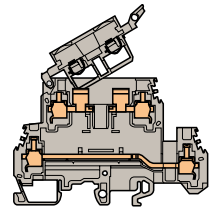
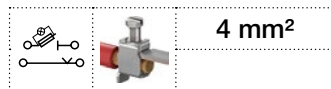

8 mm 0.315 in spacing

### With blown fuse indicator by LED

#### Ordering details

Description	Color	Type	Part Number	Pkg qty	Weight (1 pce) g
Fuse With blown fuse indicator by LED 24-60 V DC / 110 V AC	Grey	M4/8.D2.SFD3	1SNA115936R0500	50	30.00
<b>Main technical data</b>					
Rated voltage	IEC 500 V	UL	CSA	Leakage current: 24 V : < 0.5 mA	
Impulse withstand voltage	6000 V			110 V : < 2.2 mA	
Protection	IP20	NEMA 1			
CE	RoHS	Gost R			

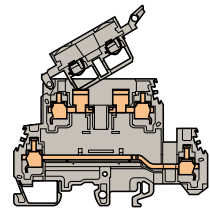

8 mm 0.315 in spacing

### With blown fuse indicator by neon

#### Ordering details

Description	Color	Type	Part Number	Pkg qty	Weight (1 pce) g
Fuse With blown fuse indicator by neon 110-230 V AC	Grey	M4/8.D2.SFL	1SNA115646R2200	50	30.00
<b>Main technical data</b>					
Rated voltage	IEC 500 V	UL 300 V	CSA 250 V	Leakage current: 110 V : < 0.5 mA	
Impulse withstand voltage	6000 V			230 V : < 0.7 mA	
Protection	IP20	NEMA 1			
CE	RoHS	UL	CSA	Gost R	

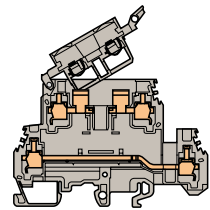
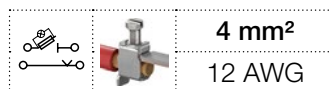

8 mm 0.315 in spacing

### With blown fuse indicator

#### Ordering details

Description	Color	Type	Part Number	Pkg qty	Weight (1 pce) g
Fuse With blown fuse indicator by LED 24 V AC/DC	Grey	M4/8.D2.SFD	1SNA115647R2300	50	30.00
<b>Main technical data</b>					
Rated voltage	IEC 500 V	UL	CSA 250 V	Leakage current: 24 V : < 4.5 mA	
Impulse withstand voltage	6000 V				
Protection	IP20	NEMA 1			
CE	RoHS	CSA	Gost R		

Technical data valid for copper conductors only.

# MTC6 thermocouple terminal blocks

Screw clamp - 6 mm 0.236 in spacing

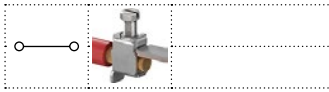

MTC6

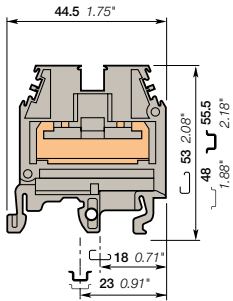

6 mm 0.236 in spacing

## Description

- Block adapted to many type of thermocouples,
- Allow thermocouple wire extension with no loss of signal integrity,
- Compatible with solid type thermocouple wires,
- Reduced inventory: only one part number needed for all configurations.

## Ordering details

Description	Color	Type	Part Number	Pkg pce	Weight (1 pce) g
Feed-through	Grey	MTC6	1SNA115206R2200	50	20
		MTC6.Ex	1SNA146227R2500	50	20

## Main technical data

	NFC	DIN	Mounting instructions	
Wire size	2 rigid thermocouple conductors 0.9 to 1.5		Rail	G32, TH 35-7.5, TH 35-15
Rated voltage	500 V		Wire stripping length	31 mm 1.22 in
Rated voltage Ex e (MTC6.Ex)	550 V IEC/EN 60079-7 - IM2/M1 II 2 GD/1 GD Ex e I/II		Torque	0.4 - 0.6 N.m 3.5 - 5.3 lb.in

The connecting capacity data for one Rigid: Solid/Stranded, or one Flexible conductor (when applicable) is a mandatory information required by IEC, UL and CSA standards (Copper conductors). All other data are provided as supplementary information only. For more details, please consult our CB, UL or CSA certificates and technical datasheet available on <http://www.te.com>

RoHS	RoHS	Gost R			
------	------	--------	--	--	--

## Notes

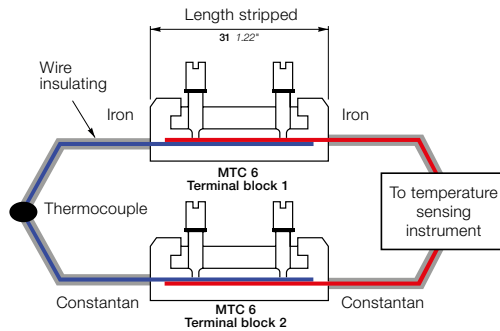

Figure 1: MTC6 with shield connector

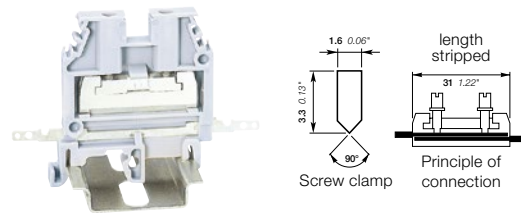

Figure 2

## Universal terminal block

Other thermocouple terminal blocks are available with hardware (screws, clamps and connecting bar) which match the thermocouple material being used. This requires inventory of many different terminal block types.

MTC6 terminal block adapts to all thermocouple material. This "neutral" method of connection limits the introduction of foreign materials to an insignificant level. The thermocouple wire insulation is stripped (31 mm maximum) and the bar wires are superimposed on each other. The thermocouple wires are in contact over their complete 31 mm length and tightened at two points by round tip screws (see figure 1). The screws, made of plated brass, have only a mechanical function, that of holding the wires together with a point contact. Thus, the pressure points are not relevant in the connection environment. One thermocouple lead connects through one terminal block (see figure 1). The MTC6 requires only 6 mm of space, allowing 50 terminals per foot of rail.

## Thermocouple shield wire connector bar

The MTC6 can be field or factory equipped with a shield connector bar (see figure 2). This bar, made of treated brass, fits in the lower part of the terminal block. It provides for the continuity of the thermocouple wire shield through the terminal block or to the ground with no additional spacing.

## Accessories

Description	Color	Type	Part Number	Pkg pce	Weight (1 pce) g
1 End sections 2.8 mm 0.110 in	Grey	FEM6	1SNA118368R1600	20	2.40
2 Shield connectors		CBM5	1SNA178745R1400	50	
3 Terminal block markers	White	RC610TT	1SNA233600R1700	22	12
		RC610	1SNA233000R0100	10	7.50

Complete list of accessories is indicated in the terminal block datasheet.

Some accessories such as jumper bars may modify the terminal block's ratings: complete information in the accessories catalogue pages.

Technical data valid for copper conductors only.



1SNC161121S0201 - Rev. C

# D2.5/6.D screw clamp terminal blocks

Sensors / Actuators - 6 mm 0.236 in spacing

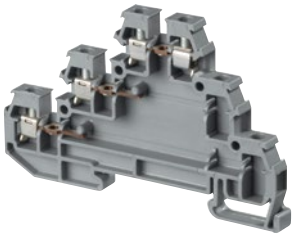

D2.5/6.D

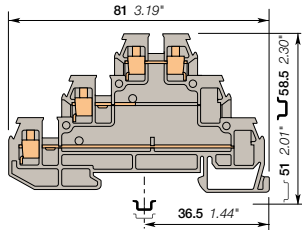

6 mm 0.236 in spacing

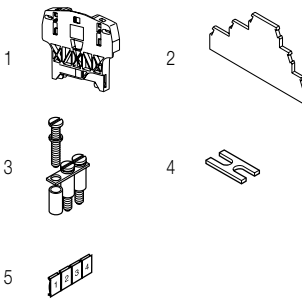

## Description

Save space with triple deck terminal blocks: adapted for 3 wires sensor/actuator in just 6 mm 0.236 in spacing.

## Ordering details

Description	Color	Type	Part Number	Pkg pce	Weight (1 pce) g
Sensor	Grey <input type="checkbox"/>	D2.5/6.D	1SNA115542R1200	25	10.00

## Main technical data

		IEC	UL	CSA
1 conductor per clamp	Rigid: Solid/Stranded	0.2-2.5 mm <sup>2</sup>	20-12 AWG	22-14 AWG
	Flexible without ferrule	0.22-2.5 mm <sup>2</sup>		
	Flexible with insulated ferrule			
	Gauge	A2		
Rated current / Rated cross section		22 A / 2.5 mm <sup>2</sup>	26 A / 12 AWG	20 A / 14 AWG
Rated short-time withstand current (1s)		300 A		
Rated voltage		380 V	300 V	300 V
Impulse withstand voltage				
Protection		IP20	NEMA 1	

## Mounting instructions

Rail		G32, TH 35-7.5, TH 35-15
Wire stripping length		6 mm 0.24 in
Tool		Flat screwdriver Ø 3.5 mm Ø 0.138 in
Torque		0.4 - 0.6 Nm 3.5 - 5.3 lb.in

The connecting capacity data for one Rigid: Solid/Stranded, or one Flexible conductor (when applicable) is a mandatory information required by IEC, UL and CSA standards (Copper conductors). All other data are provided as supplementary information only. For more details, please consult our CB, UL or CSA certificates and technical datasheet available on <http://www.te.com>

CE	RoHS	USR	CSA	Gost R

## Accessories

Description	Color	Type	Part Number	Pkg pce	Weight (1 pce) g
1 End stops	Dark grey <input type="checkbox"/>	BAZH1	1SNK900102R0000	20	24.00
2 End sections	Grey <input type="checkbox"/>	FED3E	1SNA116771R2000	20	3.80
3 Jumper bars		BJD6	1SNA178024R2500	10	1.00
			1SNA178025R2600	10	2.00
			1SNA178026R2700	10	2.00
			1SNA178027R2000	10	3.00
			1SNA178032R2500	10	6.00
			1SNA178033R2600	5	12.00
4 Cross spacing jumpers		EL61	1SNA177812R1700	10	0.10
5 Terminal block markers	White <input type="checkbox"/>	CPMF05105	1SNA235618R0000	22	1.91
			1SNA232000R0000	1	3.60

Complete list of accessories is indicated in the terminal block datasheet. Some accessories such as jumper bars may modify the terminal block's ratings: complete information in the accessories catalogue pages.

Technical data valid for copper conductors only.

# D2.5/6.DL screw clamp terminal blocks

Sensors / Actuators - 6 mm 0.236 in spacing



2.5 mm<sup>2</sup>

12 AWG

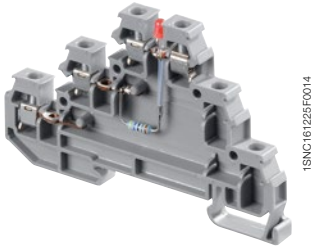

1SNC161225F0014

D2.5/6.D

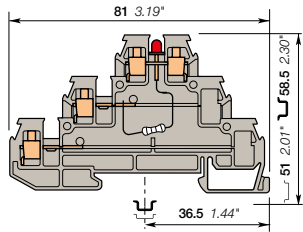

6 mm 0.236 in spacing

## Description

- Save space with triple deck terminal blocks: adapted for 3 wires sensor/actuator in just 6 mm 0.236 in spacing,
- Quickly identify the signal circuit status thanks to the indicator.

## Ordering details

Description	Color	Type	Part Number	Pkg pce	Weight (1 pce) g
<b>Sensor</b> For 3 wire sensor PNP with red 24 V DC LED and a jumper bar channel on middle and lower deck	Grey <input type="checkbox"/>	D2.5/6.DL	1SNA115537R0500	25	10.00

## Main technical data

	IEC	UL	CSA	Mounting instructions	
<b>1 conductor per clamp</b>	Rigid: Solid/Stranded Flexible without ferrule Flexible with insulated ferrule Gauge	0.2-2.5 mm <sup>2</sup> 0.22-2.5 mm <sup>2</sup> A2	20-12 AWG	22-14 AWG	<b>Rail</b> G32, TH 35-7.5, TH 35-15 <b>Wire stripping length</b> 6 mm 0.24 in <b>Tool</b> Flat screwdriver Ø 3.5 mm Ø 0.138 in
<b>Rated current / Rated cross section</b>	22 A / 2.5 mm <sup>2</sup>	26 A / 12 AWG	20 A / 14 AWG		
<b>Rated short-time withstand current (1s)</b>	300 A				
<b>Rated voltage</b>	380 V	300 V	300 V		
<b>Impulse withstand voltage</b>					
<b>Protection</b>	IP20	NEMA 1		<b>Torque</b> 0.4 - 0.6 Nm 3.5 - 5.3 lb.in	

The connecting capacity data for one Rigid: Solid/Stranded, or one Flexible conductor (when applicable) is a mandatory information required by IEC, UL and CSA standards (Copper conductors). All other data are provided as supplementary information only. For more details, please consult our CB, UL or CSA certificates and technical datasheet available on <http://www.te.com>

--	--	--	--	--	--	--	--	--	--

## Accessories

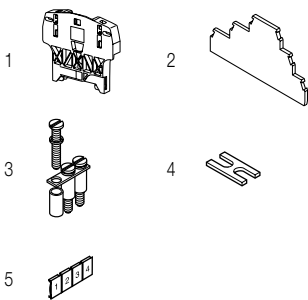

Description	Color	Type	Part Number	Pkg pce	Weight (1 pce) g
<b>1 End stops</b> 10 mm 0.394 in	Dark grey <input checked="" type="checkbox"/>	BAZH1	1SNK900102R0000	20	24.00
<b>2 End sections</b> 3 mm 0.118 in	Grey <input type="checkbox"/>	FED3E	1SNA116771R2000	20	3.80
<b>3 Jumper bars</b> 2 poles 22 A		BJD6	1SNA178024R2500	10	1.00
3 poles			1SNA178025R2600	10	2.00
4 poles			1SNA178026R2700	10	2.00
5 poles			1SNA178027R2000	10	3.00
10 poles			1SNA178032R2500	10	6.00
20 poles			1SNA178033R2600	5	12.00
<b>4 Cross spacing jumpers</b> 5 mm 0.200 in - 6 mm 0.236 in - 8 mm 0.315 in		EL61	1SNA177812R1700	10	0.10
<b>5 Terminal block markers</b> Blank card	White <input type="checkbox"/>	CPMF05105 RC65	1SNA235618R0000 1SNA232000R0000	22 1	1.91 3.60

Complete list of accessories is indicated in the terminal block datasheet.  
Some accessories such as jumper bars may modify the terminal block's ratings: complete information in the accessories catalogue pages.

Technical data valid for copper conductors only.

# A COMPACT AND ALIGNED SOLUTION FOR YOUR CONTROL SYSTEM

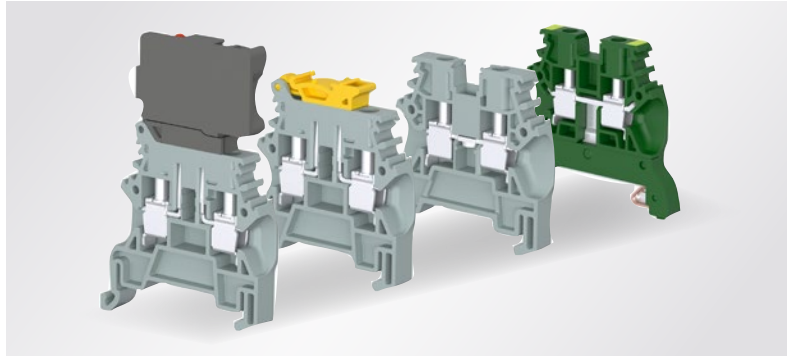

Marshalling cabinets typically require the use of a large number of digital or analog signals as well as actuator's outputs. Indeed, marshalling cabinets provide for an important cross wiring function, since the incoming field signal and the channel quantity of the I/O card of the controller (DCS, large PLC's) is always different.

They facilitate the maintenance operations and ease the system modifications.

The SNACompact terminal blocks specially designed for DCS marshalling application now include a full set of aligned terminal blocks: fuse, disconnect, feed-through and ground terminal blocks with identical profile to provide compact and convenient solution. With a spacing of only 6 mm they reduce the required space in your cabinet. Dedicated lateral jumper bars help the jumpering between adjacent or alternate terminal blocks.

## TYPICAL MARSHALLING CONFIGURATIONS

### DIGITAL SIGNALS

Signal protection with fuse.  
Potential distribution with double special lateral jumper.

Fuse and disconnect function to allow isolation of the electrical circuit.

### ANALOG

Ground terminal blocks allow reliable connection of cable shields to the ground sparing the use of external shield bar. Potential distribution for analog signal.

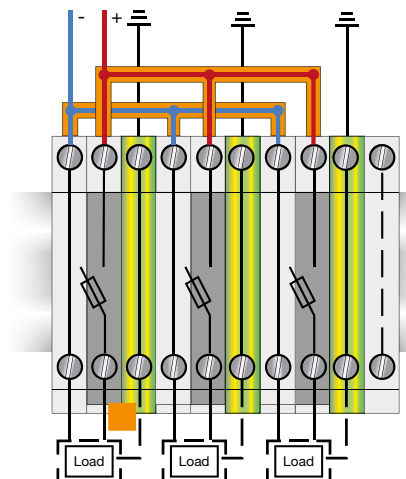
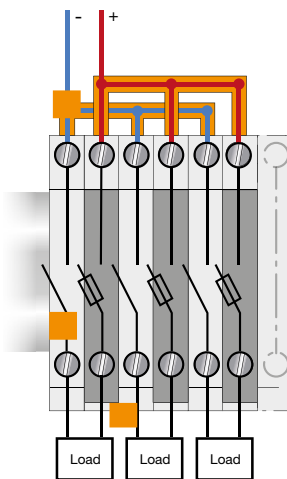
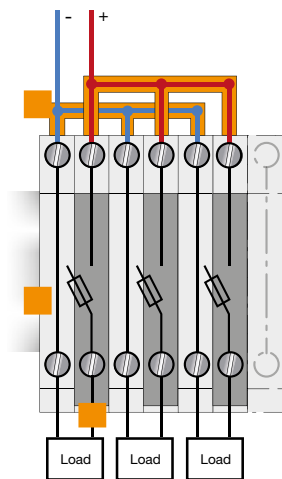

C4/6



C4/6.SF..



C4/6.S



C4/6.P

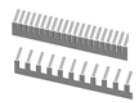

LJB6-xx

# DR1.5/4 screw clamp terminal blocks

Miniblocks - 4 mm 0.157 in spacing



1.5 mm<sup>2</sup>

## Description

Save space with compact over-all dimensions terminal block.

## Ordering details

Description	Color	Type	Part Number	Pkg pce	Weight (1 pce) g
Miniblocks Feed-through	Grey <input type="checkbox"/>	DR1.5/4	1SNA110106R2500	50	3.00

## Main technical data

		IEC	UL	CSA	Mounting instructions	
1 conductor per clamp	Rigid: Solid/Stranded	0.2-1.5 mm <sup>2</sup>			Rail	TH 15-5.5
	Flexible without ferrule	0.22-1.5 mm <sup>2</sup>			Wire stripping length	7 mm / 0.275 in
	Flexible with insulated ferrule				Tool	Flat screwdriver Ø 2.5 mm Ø 0.98 in
	Gauge	A1			Torque	0.4 - 0.6 Nm 3.5 - 5.3 lb.in
<b>Rated current / Rated cross section</b>		17.5 A / 1.5 mm <sup>2</sup>				
<b>Rated short-time withstand current (1s)</b>		180 A				
<b>Rated voltage</b>		500 V				
<b>Impulse withstand voltage</b>		6000 V				
<b>Protection</b>		IP20 NEMA 1				

The connecting capacity data for one Rigid: Solid/Stranded, or one Flexible conductor (when applicable) is a mandatory information required by IEC, UL and CSA standards (Copper conductors). All other data are provided as supplementary information only. For more details, please consult our CB, UL or CSA certificates and technical datasheet available on <http://www.te.com>

--	--	--	--	--	--	--

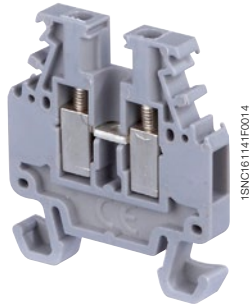

DR1.5/4

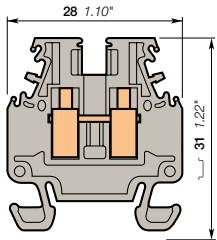

4 mm 0.157 in spacing

## Accessories

Description	Color	Type	Part Number	Pkg pce	Weight (1 pce) g
1 End stops 6.5 mm 0.256 in	Grey <input type="checkbox"/>	BADRL	1SNA199420R2100	50	2.00
2 End sections 1 mm 0.039 in	Grey <input type="checkbox"/>	FED2-4	1SNA215580R2100	25	1.40
3 Jumper bars 2 poles 17.5 A		BJM4	1SNA205735R0600	10	1.00
			1SNA205736R0700	10	2.00
			1SNA205737R0000	10	3.00
			1SNA205738R1100	10	6.00
4 Circuit separators 0.3 mm 0.012 in	White <input type="checkbox"/>	SCDR61	1SNA173016R1000	25	0.40
5 Terminal block markers	White <input type="checkbox"/>	CPMF05105	1SNA235618R0000	22	1.91
			1SNA229000R1500	1	5.16

Complete list of accessories is indicated in the terminal block datasheet.

Some accessories such as jumper bars may modify the terminal block's ratings: complete information in the accessories catalogue pages.

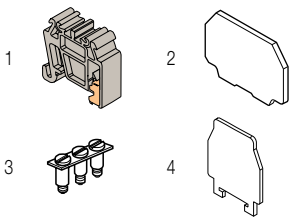

Technical data valid for copper conductors only.

# DR1.5/5 screw clamp terminal blocks

Miniblocks - 5 mm 0.197 in spacing

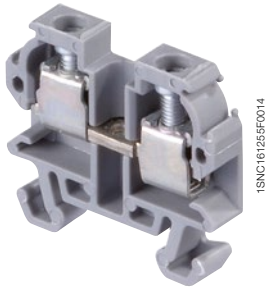

DR1.5/5

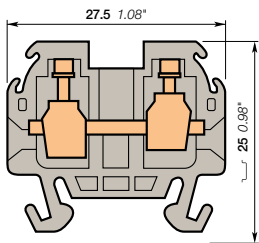

5 mm 0.197 in spacing

## Description

Save space with compact over-all dimensions terminal block.

## Ordering details

Description	Color	Type	Part Number	Pkg pce	Weight (1 pce) g
Miniblocks Feed-through	Grey <input type="checkbox"/>	DR1.5/5	1SNA115510R1600	100	5.00

## Main technical data

		IEC	UL	CSA
1 conductor per clamp	Rigid: Solid/Stranded	0.2-2.5 mm <sup>2</sup>	28 - 12 AWG	28 - 14 AWG
	Flexible without ferrule	0.22-1.5 mm <sup>2</sup>		
	Flexible with insulated ferrule			
	Gauge			
Rated current / Rated cross section		20 A / 1.5 mm <sup>2</sup>	20 A / 12 AWG	20 A / 14 AWG
Rated short-time withstand current (1s)		180 A		
Rated voltage		250 V	300 V	300 V
Impulse withstand voltage				
Protection		IP20	NEMA 1	

## Mounting instructions

Rail		TH 15-5.5
Wire stripping length		8.5 mm 0.335 in
Tool		Flat screwdriver Ø 3.5 mm Ø 0.138 in
Torque		0.4 - 0.6 Nm 3.5 - 5.3 lb.in

The connecting capacity data for one Rigid: Solid/Stranded, or one Flexible conductor (when applicable) is a mandatory information required by IEC, UL and CSA standards (Copper conductors). All other data are provided as supplementary information only. For more details, please consult our CB, UL or CSA certificates and technical datasheet available on <http://www.te.com>

CE	RoHS	USR	CSA	Gost R

## Accessories

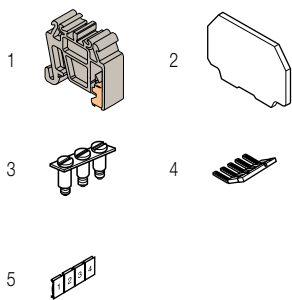

Description	Color	Type	Part Number	Pkg pce	Weight (1 pce) g
1 End stops	Grey <input type="checkbox"/>	BADRL	1SNA199420R2100	50	2.00
2 End sections	Grey <input type="checkbox"/>	FEDR5	1SNA117318R2300	25	0.80
3 Jumper bars		BJMI5DR	1SNA176704R0200	10	2.00
			1SNA176705R0300	10	3.00
			1SNA176706R0400	10	4.00
			1SNA176708R1600	10	12.00
4 Lateral jumper bars		PC51-10	1SNA167908R0600	10	5.00
5 Terminal block markers	White <input type="checkbox"/>		CPMF05105	22	1.91
			RC55	1	2.90

Complete list of accessories is indicated in the terminal block datasheet. Some accessories such as jumper bars may modify the terminal block's ratings: complete information in the accessories catalogue pages.

Technical data valid for copper conductors only.



# DR4/6 screw clamp terminal blocks

Miniblocks - 6 mm 0.236 in spacing

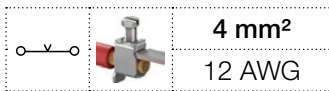

DR4/6

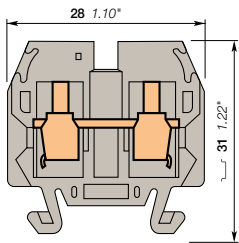

6 mm 0.236 in spacing

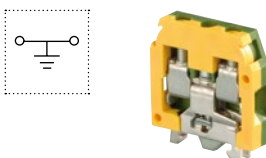
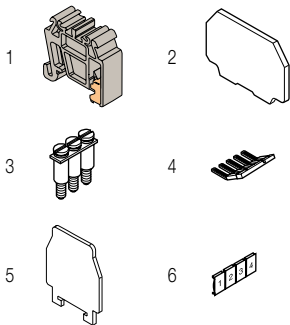

## Description

Save space with compact over-all dimensions terminal block.

## Ordering details

Description	Color	Type	Part Number	Pkg pce	Weight (1 pce) g
Miniblocks Feed-through	Grey <input type="checkbox"/>	DR4/6	1SNA110251R0500	50	6.00
	Blue <input type="checkbox"/>	DR4/6.N	1SNA120251R0700	50	6.00

## Main technical data

	IEC	UL	CSA	Mounting instructions	
<b>1 conductor per clamp</b>	Rigid: Solid/Stranded Flexible without ferrule Flexible with insulated ferrule Gauge	0.2-4 mm <sup>2</sup> 0.22-4 mm <sup>2</sup>	22 - 12 AWG	28-10 AWG	Rail  TH 15-5.5
<b>Rated current / Rated cross section</b>	30 A / 4 mm <sup>2</sup>	20 A / 12 AWG	25 A / 10 AWG	Wire stripping length  9.5 mm 0.37 in	
<b>Rated short-time withstand current (1s)</b>	480 A			Tool  Flat screwdriver Ø 4 mm Ø 0.157 in	
<b>Rated voltage</b>	500 V	250 V	600 V	Torque  0.5 - 0.8 Nm 4.4 - 7.1 lb.in	
<b>Impulse withstand voltage</b>					
<b>Protection</b>	IP20	NEMA 1			

The connecting capacity data for one Rigid: Solid/Stranded, or one Flexible conductor (when applicable) is a mandatory information required by IEC, UL and CSA standards (Copper conductors). All other data are provided as supplementary information only. For more details, please consult our CB, UL or CSA certificates and technical datasheet available on <http://www.te.com>

--	--	--	--	--	--	--	--	--	--

## Accessories

Description	Color	Type	Part Number	Pkg pce	Weight (1 pce) g	
1 End stops 6.5 mm 0.256 in	Grey <input type="checkbox"/>	BADRL	1SNA199420R2100	50	2.00	
2 End sections 1 mm 0.039 in	Grey <input type="checkbox"/>	FEDR61	1SNA117600R0300	25	0.80	
3 Jumper bars 2 poles 32 A		BJM62	1SNA173217R2600	10	2.00	
			3 poles	1SNA173218R0700	10	3.00
			4 poles	1SNA173219R0000	10	4.00
			10 poles	1SNA173226R2700	10	10.00
4 Lateral jumper bars 10 poles 35 A		PC61-10	1SNA163311R2200	10	5.00	
5 Circuit separators 0.3 mm 0.012 in	White <input type="checkbox"/>	SCDR61	1SNA173016R1000	25	0.40	
6 Terminal block markers	White <input type="checkbox"/>	CPMF05105	1SNA235618R0000	22	1.91	
		RC65	1SNA232000R0000	1	3.60	

Complete list of accessories is indicated in the terminal block datasheet. Some accessories such as jumper bars may modify the terminal block's ratings: complete information in the accessories catalogue pages.

## Ground screw clamp terminal blocks

Description	Color	Type	Part Number	Pkg pce	Weight (1 pce) g
Ground Profile aligned with DR4/6...	Green-yellow <input type="checkbox"/>	DR4/6.P	1SNA160496R2600	50	10.00

Technical data valid for copper conductors only.

# DR4/6.P screw clamp terminal blocks

Miniblocks - 6 mm 0.236 in spacing

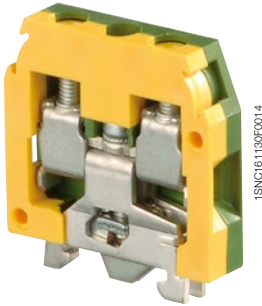
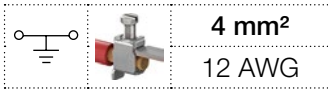

DR4/6.P

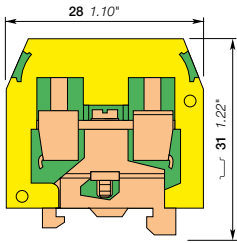

6 mm 0.236 in spacing

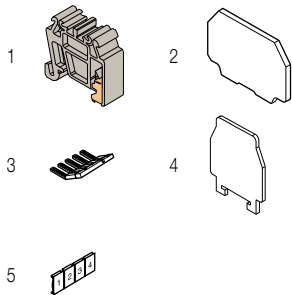

## Description

- Save space with compact over-all dimensions terminal block,
- For DIN 2 rail,
- Reliable electrical and mechanical contact with the rail.

## Ordering details

Description	Color	Type	Part Number	Pkg pce	Weight (1 pce) g
Ground Screwless rail connection	Green-yellow	DR4/6.P	1SNA160496R2600	50	10.00

## Main technical data

		IEC	UL	CSA	Mounting instructions	
1 conductor per clamp	Rigid: Solid/Stranded	0.2-4 mm <sup>2</sup>	22-12 AWG	28-10 AWG	Wire stripping length	9.5 mm 0.37 in
	Flexible without ferrule	0.22-4 mm <sup>2</sup>			Screw clamp Tool	Flat screwdriver Ø 4 mm Ø 0.157 in
	Flexible with insulated ferrule Gauge					
Rated cross section		4 mm <sup>2</sup>	12 AWG	10 AWG		
Rated short-time withstand current (1s)		480 A				

The connecting capacity data for one Rigid: Solid/Stranded, or one Flexible conductor (when apply) is a mandatory information required by IEC, UL and CSA standards (Copper conductors). All other data are provided as supplementary information only. For more details, please consult our CB, UL or CSA certificates and technical datasheet available on <http://www.te.com>

CE	RoHS	UL	cSAus	Gost R															
----	------	----	-------	--------	--	--	--	--	--	--	--	--	--	--	--	--	--	--	--

## Accessories

Description	Color	Type	Part Number	Pkg pce	Weight (1 pce) g
1 End stops 6.5 mm 0.256 in	Grey	BADRL	1SNA199420R2100	50	2.00
2 End sections 1 mm 0.039 in	Grey	FEDR61	1SNA117600R0300	25	0.80
3 Lateral jumper bars 10 poles 35 A		PC61-10	1SNA163311R2200	10	5.00
4 Circuit separators 0.3 mm 0.012 in	White	SCDR61	1SNA173016R1000	25	0.40
5 Terminal block markers Blank card	White	CPMF05105	1SNA235618R0000	22	1.91
		RC65	1SNA232000R0000	1	3.60

Complete list of accessories is indicated in the terminal block datasheet. Some accessories such as jumper bars may modify the terminal block's ratings: complete information in the accessories catalogue pages.

Technical data valid for copper conductors only.

## Accessories Contents

PR mounting rail.....	p. 69
Screw end stops.....	p. 73
Label holder .....	p. 76
BJC screw Jumper bars.....	p. 77
PC lateral jumper bars.....	p. 78

# PR mounting rail

Common terminal block accessories



1SNA500072F0000

PR30

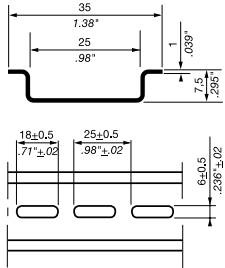

2000 mm 78.74 in spacing

## Description

- Pre-punched symmetrical mounting rail,
- The slotted holes ease the mounting and allow to use existing and/or numerous fixings,
- Particularly well designed for fixing onto back-plates and for terminal assemblies of small dimensions.

## Ordering details

Description	Color	Type	Part Number	Pkg meter	Weight (1 pce) g
Prepunched rail		PR30	1SNA173220R0500	2	328.00

Please note that for all rails: 1 part number equal 1 meter (39 in). Packing of 2 meters (78 in) minimum.  
Check that your order quantity is a multiple of 2.

## Main technical data

Material	Zinc plating and passivation steel				
Rail	TH 35-7.5				
	IEC	UL - CSA			
Equivalent E-Cu cross section	All the main technical data provided are "manufacturer" values.				
RoHS					

## Mounting instructions

- In order to guarantee the performances and security of your installation, please ensure the rail and its fixings can withstand the static and dynamic loads of the components mounted on it;
- To prevent the rail from flexing (1 mm 0.039 in rail thickness only), fixing is recommended every 250 mm 9.84 in;
- To prevent any issues during mounting, screw heads used for rail fixing should not protrude from the rail (7,5 mm 0.295 in rail height only).

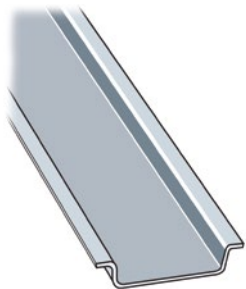

1SNA500073F0000

PR3.Z2

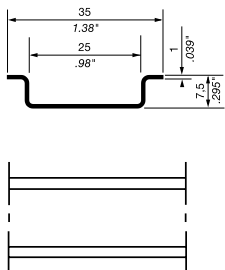

2000 mm 78.74 in spacing

## Description

- Symmetrical mounting rail complying with IEC60715,
- Particularly well designed for fixing onto back-plates and for terminal assemblies of small dimensions.

## Ordering details

Description	Color	Type	Part Number	Pkg meter	Weight (1 pce) g
		PR3.Z2	1SNA174300R1700	2	718.00

Please note that for all rails: 1 part number equal 1 meter (39 in). Packing of 2 meters (78 in) minimum.  
Check that your order quantity is a multiple of 2.

## Main technical data

Material	Zinc plating and passivation steel				
Rail	TH 35-7.5				
	IEC	UL - CSA			
Equivalent E-Cu cross section	16 mm <sup>2</sup>				
	All the main technical data provided are "manufacturer" values.				
RoHS					

## Mounting instructions

- In order to guarantee the performances and security of your installation, please ensure the rail and its fixings can withstand the static and dynamic loads of the components mounted on it;
- To prevent the rail from flexing (1 mm 0.039 in rail thickness only), fixing is recommended every 250 mm 9.84 in;
- To prevent any issues during mounting, screw heads used for rail fixing should not protrude from the rail (7,5 mm 0.295 in rail height only).

Technical data valid for copper conductors only.

# PR mounting rail

Common terminal block accessories

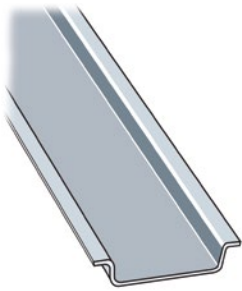

1SNK60073F0000

PR3.G2

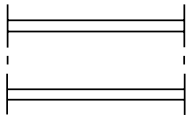
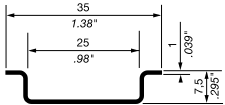

2000 mm 78.74 in spacing

## Description

- Symmetrical mounting rail made of galvanised steel, complying with IEC60715,
- Particularly well designed for fixing onto back-plates and for terminal assemblies of small dimensions.

## Ordering details

Description	Color	Type	Part Number	Pkg meter	Weight (1 pce) g
		PR3.G2	1SNA164800R0300	2	718.00

Please note that for all rails: 1 part number equal 1 meter (39 in). Packing of 2 meters (78 in) minimum. Check that your order quantity is a multiple of 2.

## Main technical data

Material	Galvanised steel				
Rail	TH 35-7.5				
	IEC	UL - CSA			
Equivalent E-Cu cross section	16 mm <sup>2</sup>				
All the main technical data provided are "manufacturer" values.					
RoHS					
RoHS					

## Mounting instructions

- In order to guarantee the performances and security of your installation, please ensure the rail and its fixings can withstand the static and dynamic loads of the components mounted on it;
- To prevent the rail from flexing (1 mm 0.039 in rail thickness only), fixing is recommended every 250 mm 9.84 in;
- To prevent any issues during mounting, screw heads used for rail fixing should not protrude from the rail (7,5 mm 0.295 in rail height only).

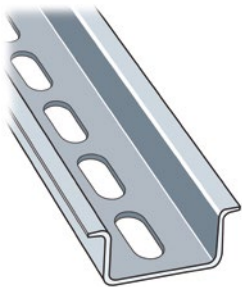

1SNK60074F0000

PR50

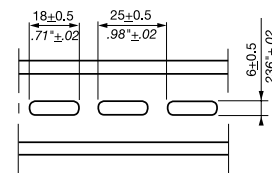
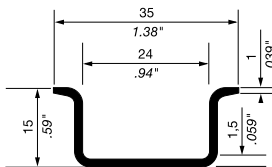

2000 mm 78.74 in spacing

## Description

- Pre-punched symmetrical mounting rail,
- The slotted holes ease the mounting and allow to use existing and/or numerous fixings.

## Ordering details

Description	Color	Type	Part Number	Pkg meter	Weight (1 pce) g
Prepunched rail		PR50	1SNA178529R0400	2	1288.00

Please note that for all rails: 1 part number equal 1 meter (39 in). Packing of 2 meters (78 in) minimum. Check that your order quantity is a multiple of 2.

## Main technical data

Material	Zinc plating and passivation steel				
Rail	TH 35-15				
	IEC	UL - CSA			
Equivalent E-Cu cross section					
All the main technical data provided are "manufacturer" values.					
RoHS					
RoHS					

## Mounting instructions

- In order to guarantee the performances and security of your installation, please ensure the rail and its fixings can withstand the static and dynamic loads of the components mounted on it;
- To prevent the rail from flexing, fixing is recommended every 700 mm 27.6 in;
- In order to increase the accessibility of your terminal assembly, we recommend the use of our rail offset brackets EM45 (order code 1SNA008521R2600) for a 45° orientation of the rail.

Technical data valid for copper conductors only.

# PR mounting rail

Common terminal block accessories

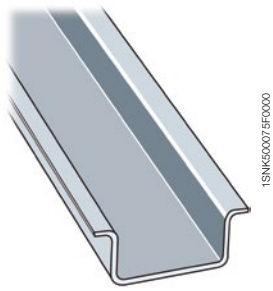

1SNK500075F0000

PR5

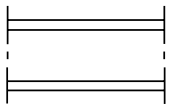
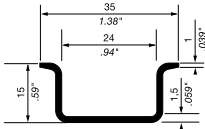

2000 mm 78.74 in spacing

## Description

- Symmetrical mounting rail.

## Ordering details

Description	Color	Type	Part Number	Pkg meter	Weight (1 pce) g
		PR5	1SNA168700R2200	2	1200.00

Please note that for all rails: 1 part number equal 1 meter (39 in). Packing of 2 meters (78 in) minimum. Check that your order quantity is a multiple of 2.

## Main technical data

Material	Zinc plating and passivation steel
Rail	TH 35-15

IEC	UL - CSA
-----	----------

## Equivalent E-Cu cross section

All the main technical data provided are "manufacturer" values.

RoHS	RoHS
------	------

## Mounting instructions

- In order to guarantee the performances and security of your installation, please ensure the rail and its fixings can withstand the static and dynamic loads of the components mounted on it;
- To prevent the rail from flexing, fixing is recommended every 700 mm 27.6 in;
- In order to increase the accessibility of your terminal assembly, we recommend the use of our rail offset brackets EM45 (order code 1SNA008521R2600) for a 45° orientation of the rail.

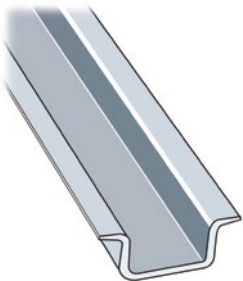

1SNK50006F0000

PR4

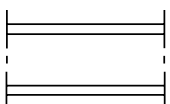
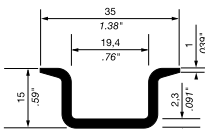

2000 mm 78.74 in spacing

## Description

- Symmetrical mounting rail complying with IEC 60715,
- The rigidity of the rail is maximised by the 2.3 mm 0.090 in thickness of the rail, and by its solid, non slotted construction,
- PR4 TH 35-15 is the most rigid mounting rail solution.

## Ordering details

Description	Color	Type	Part Number	Pkg meter	Weight (1 pce) g
Recommended for SNK ground terminal blocks up to 35 mm <sup>2</sup> 2 AWG		PR4	1SNA168500R1200	2	915.00

Please note that for all rails: 1 part number equal 1 meter (39 in). Packing of 2 meters (78 in) minimum. Check that your order quantity is a multiple of 2.

## Main technical data

Material	Zinc plating and passivation steel
Rail	TH 35-15

IEC	UL - CSA
-----	----------

## Equivalent E-Cu cross section

All the main technical data provided are "manufacturer" values.

50 mm <sup>2</sup>	2 AWG
RoHS	RoHS

## Mounting instructions

- In order to guarantee the performances and security of your installation, please ensure the rail and its fixings can withstand the static and dynamic loads of the components mounted on it;
- To prevent the rail from flexing, fixing is recommended every 700 mm 27.6 in;
- In order to increase the accessibility of your terminal assembly, we recommend the use of our rail offset brackets EM45 (order code 1SNA008521R2600) for a 45° orientation of the rail.

Technical data valid for copper conductors only.

# PR mounting rail

Common terminal block accessories

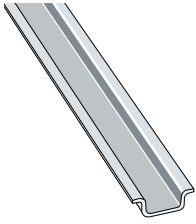

1SNC220057F0000

PR2P

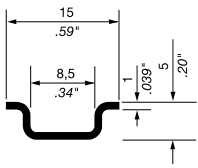

2000 mm 78.74 in spacing



1SNC220058F0000

PR2

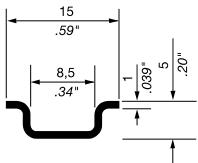

2000 mm 78.74 in spacing

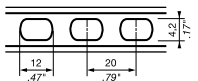

## Description

- Symmetrical mounting rail.
- Particularly well designed for fixing miniblocks and for terminal assemblies of small dimensions.

## Ordering details

Description	Color	Type	Part Number	Pkg meter	Weight (1 pce) g
		PR2P	1SNA206596R2500	2	330

Please note that for all rails: 1 part number equal 1 meter (39 in). Packing of 2 meters (78 in) minimum. Check that your order quantity is a multiple of 2.

## Main technical data

Material	Zinc plating and passivation steel				
Rail	TH15-5.5				
	IEC	UL - CSA			
Equivalent E-Cu cross section					
All the main technical data provided are "manufacturer" values.					
RoHS					

## Mounting instructions

- In order to guarantee the performances and security of your installation, please ensure the rail and its fixings can withstand the static and dynamic loads of the components mounted on it;
- To prevent the rail from flexing (1 mm 0.039 in rail thickness only), fixing is recommended every 250 mm 9.84 in;
- To prevent any issues during mounting, screw heads used for rail fixing should not protrude from the rail (7,5 mm 0.295 in rail height only).

## Description

- Symmetrical prepunched compact mounting rail made of passivated,
- Particularly well designed for fixing miniblocks and for terminal assemblies of small dimensions.

## Ordering details

Description	Color	Type	Part Number	Pkg meter	Weight (1 pce) g
Recommended for SNK ground terminal blocks up to 35 mm <sup>2</sup> 2 AWG		PR2	1SNA164600R1200	2	280

Please note that for all rails: 1 part number equal 1 meter (39 in). Packing of 2 meters (78 in) minimum. Check that your order quantity is a multiple of 2.

## Main technical data

Material	Zinc plating and passivation steel				
Rail	TH15-5.5				
	IEC	UL - CSA			
Equivalent E-Cu cross section					
All the main technical data provided are "manufacturer" values.					
RoHS					

## Mounting instructions

- In order to guarantee the performances and security of your installation, please ensure the rail and its fixings can withstand the static and dynamic loads of the components mounted on it;
- To prevent the rail from flexing, fixing is recommended every 700 mm 27.6 in;
- In order to increase the accessibility of your terminal assembly, we recommend the use of our rail offset brackets EM45 (order code 1SNA008521R2600) for a 45° orientation of the rail.

Technical data valid for copper conductors only.

1SNC160103S0201



# Screw end stops

Common terminal block accessories

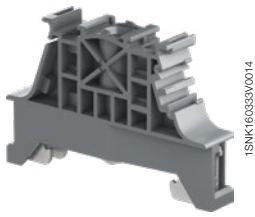

1SNK160333V0014

BAM4

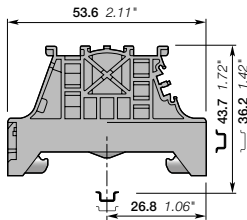

10 mm 0.394 in spacing

## Mounting instructions



## BAM4 screw end stops

### Description

- Give efficient support to the SNK terminal blocks assemblies thanks to the BAM4 double gripping rail contact,
- Ease the assemblies identification with the BAM4 marking location compatible with all SNK markers and labels.

### Ordering details

Description	Color	Type	Part Number	Pkg qty	Weight (1 pce) g
10 mm 0.394 in spacing	Dark grey	BAM4	1SNK90001R0000	50	14.00

### Main technical data

Material specifications	Insulating material	Polyamide	Rail		TH 35-7.5, TH 35-15
	Flammability	V0	Tool		Flat screwdriver
	NF F 16 101	I2F2	Torque		Ø 5.5 mm Ø 0.217 in
Ambient temperature min/max	Service IEC 60068-2-1	-55 ... +110 °C -67 ... +230 °F			0.9 Nm ± 0.1
	Storage	-55 ... +110 °C -67 ... +230 °F			7.08 lb.in ± 0.88
	Installing	-5 ... +40 °C +23 ... +104 °F			

### Mounting instructions

All the main technical data provided are "manufacturer" values

RoHS	RoHS
<input type="checkbox"/>	<input type="checkbox"/>

### Accessories

Description	Color	Type	Part Number	Pkg qty	Weight (1 pce) g
Blank card	In polycarbonate	White <input type="checkbox"/>	MC812	22	10.00
	In polyamide		MC812PA	20	14.00
Label holder	10 mm 0.394 in width	Dark grey <input checked="" type="checkbox"/>	LH	50	0.60
	19.5 mm 0.768 in width		LH-R1	50	1.10
Universal wire markers holder	5.2 mm 0.205 in spacing	Grey <input type="checkbox"/>	UMH	10	0.20

## BAZH1 screw end stops

### Description

- Give efficient support to the SNK double deck or power terminal blocks assemblies thanks to the BAZH1 double gripping rail contact,
- Ease the assemblies identification with label holders.

### Ordering details

Description	Color	Type	Part Number	Pkg qty	Weight (1 pce) g
10 mm 0.394 in spacing	Dark grey	BAZH1	1SNK900102R0000	20	24.00

### Main technical data

Material specifications	Insulating material	Polyamide	Rail		TH 35-7.5
	Flammability	V0	Tool		Flat screwdriver
	NF F 16 101	I2F2	Torque		Ø 5.5 mm Ø 0.217 in
Ambient temperature min/max	Service IEC 60068-2-1	-55 ... +110 °C -67 ... +230 °F			1.3 Nm ± 0.1
	Storage	-55 ... +110 °C -67 ... +230 °F			11.4 lb.in ± 0.88
	Installing	-5 ... +40 °C +23 ... +104 °F			

### Mounting instructions

All the main technical data provided are "manufacturer" values

RoHS	RoHS
<input type="checkbox"/>	<input type="checkbox"/>

### Accessories

Description	Color	Type	Part Number	Pkg qty	Weight (1 pce) g
Blank card	In polycarbonate	White <input type="checkbox"/>	MC812	22	10.00
	In polyamide		MC812PA	20	14.00
Label holder	10 mm 0.394 in width	Dark grey <input checked="" type="checkbox"/>	LH	50	0.60
	19.5 mm 0.768 in width		LH-R1	50	1.10
Universal wire markers holder	5.2 mm 0.205 in spacing	Grey <input type="checkbox"/>	UMH	10	0.20

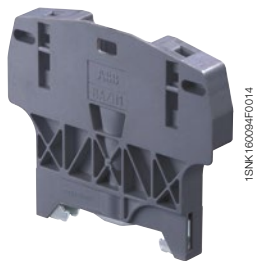

1SNK160094R0014

BAZH1

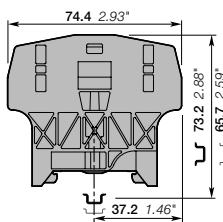

10 mm 0.394 in spacing

Technical data valid for copper conductors only.

# Screwless end stops

Common terminal block accessories



BAZ1

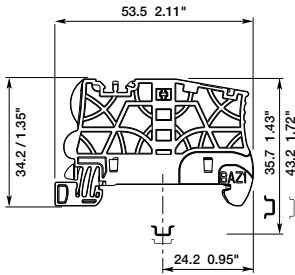

5.2 mm 0.205 in spacing

## BAZ1 screwless end stops

### Description

- Reduce the size of your terminal block assemblies with the screwless reduced spacing BAZ1 end stop,
- Ease the assemblies identification with various markers and label holders.

### Ordering details

Description	Color	Type	Part Number	Pkg qty	Weight (1 pce) g
5.2 mm 0.205 in spacing	Dark grey <input checked="" type="checkbox"/>	BAZ1	1SNK900002R0000	50	5.30

### Main technical data

Material specifications	Insulating material	Polyamide	
	Flammability	V0	
Ambient temperature min/max	NF F 16 101	I2F2	
	Service IEC 60068-2-1	-55 ... +110 °C	-67 ... +230 °F
	Storage	-55 ... +110 °C	-67 ... +230 °F
	Installing	-5 ... +40 °C	+23 ... +104 °F

### Mounting instructions

Rail		TH 35-7.5
------	--	-----------

All the main technical data provided are "manufacturer" values

<b>RoHS</b>	<input checked="" type="checkbox"/>	RoHS
-------------	-------------------------------------	------

### Accessories

Description	Color	Type	Part Number	Pkg qty	Weight (1 pce) g
Blank card	White <input type="checkbox"/>	MC512	1SNK140000R0000	22	9.00
		MC512PA	1SNK149999R0000	20	10.00
Label holder	Dark grey <input checked="" type="checkbox"/>	LH	1SNK9000605R0000	50	0.60
		LH-R1	1SNK9000607R0000	50	1.10
Universal wire markers holder	Grey <input type="checkbox"/>	UMH	1SNK9000611R0000	10	0.20

Technical data valid for copper conductors only.

# Screw end stops

Common terminal block accessories



1SNC160644/0014

BADRL

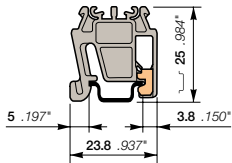

6.5 mm 0.256 in spacing

## BADRL screwless end stops

### Description

- Reduce the size of your terminal block assemblies with the screwless reduced spacing BADRL end stop,
- Compatible with TH15-5.5 compact rail and miniblocks.

### Ordering details

Description	Color	Type	Part Number	Pkg qty	Weight (1 pce) g
6.5 mm 0.256 in spacing	Grey <input type="checkbox"/>	BADRL	1SNA199420R2100	50	2.00

### Main technical data

Material specifications		Insulating material		Polyamide		Rail		Mounting instructions	
Flammability		NF F 16 101		V0		I2F2		TH15-5,5	
Ambient temperature min/max		Service IEC 60068-2-1		-55 ... +110 °C		-67 ... +230 °F			
		Storage		-55 ... +110 °C		-67 ... +230 °F			
		Installing		-5 ... +40 °C		+23 ... +104 °F			

All the main technical data provided are "manufacturer" values

RoHS		RoHS							
------	--	------	--	--	--	--	--	--	--

### Accessories

Description	Color	Type	Part Number	Pkg qty	Weight (1 pce) g
Blank card	White <input type="checkbox"/>	RC610TT	1SNA233600R1700	22	12.00
		RC610	1SNA233000R0100	10	7.00

Technical data valid for copper conductors only.

## Label holder

Common terminal block accessories



1SNK1603340014

LH

10 mm 0.394 in spacing

## LH label holder

### Description

- Easily identify your terminal blocks assembly with white or yellow labels,
- Adjustable in height for best visibility,
- Compatible with TE SNK end stops.

### Ordering details

Description	Color	Type	Part Number	Pkg qty	Weight (1 pce) <b>g</b>
10 mm 0.394 in width	Dark grey <input checked="" type="checkbox"/>	LH	1SNK900605R0000	50	0.60

### Main technical data

<b>Material specifications</b>	Insulating material	Polyamide			
	Flammability	V0			
	NF F 16 101	I2F2			
<b>Ambient temperature min/max</b>	Service IEC 60068-2-1	-55 ... +110 °C	-67 ... +230 °F		
	Storage	-55 ... +110 °C	-67 ... +230 °F		
	Installing	-5 ... +40 °C	+23 ... +104 °F		

All the main technical data provided are "manufacturer" values

RoHS  
RoHS

### Accessories

Description	Color	Type	Part Number	Pkg qty	Weight (1 pce) <b>g</b>
Self-adhesive precut blank label compatible with HTP600	White <input type="checkbox"/>	MCLH	1SNK900630R0000	25	10.00
Self-adhesive precut blank label compatible with HTP600	White <input type="checkbox"/>	RCPEAD-TT	1SNA235158R0100	25	9.80
Self-adhesive precut blank label compatible with HTP600	Yellow <input checked="" type="checkbox"/>	RCPEAD-TT-YL	1SNA235159R0200	25	12.10
Pre-printed cover marker Protection for RCPEAD markers	Transparent <input checked="" type="checkbox"/>	EPR2	1SNA399726R0700	10	4.00
Precut blank label compatible with MG3	White <input type="checkbox"/>	MG-TAR 45490	1SNB045490R8530	1650	0.371
Self-adhesive precut blank label compatible with MG3	Yellow <input checked="" type="checkbox"/>	MG-TAA 49448	1SNB049448R8530	825	0.55
Self-adhesive precut blank label compatible with MG3	White <input type="checkbox"/>	MG-TAA 49498	1SNB049498R8530	825	0.55
Self-adhesive precut blank label compatible with HTP600	Yellow <input checked="" type="checkbox"/>	MCLH-YL	1SNK900633R0000	25	10.00



1SNK160350014

LH-R1

19.5 mm 0.768 in spacing

## LH-R1 label holder

### Description

- Easily identify your terminal blocks assembly with white or yellow labels,
- Adjustable in height for best visibility,
- Compatible with TE SNK end stops.

### Ordering details

Description	Color	Type	Part Number	Pkg qty	Weight (1 pce) <b>g</b>
19.5 mm 0.768 in width	Dark grey <input checked="" type="checkbox"/>	LH-R1	1SNK900607R0000	50	1.10

### Main technical data

<b>Material specifications</b>	Insulating material	Polyamide			
	Flammability	V0			
	NF F 16 101	I2F2			
<b>Ambient temperature min/max</b>	Service IEC 60068-2-1	-55 ... +110 °C	-67 ... +230 °F		
	Storage	-55 ... +110 °C	-67 ... +230 °F		
	Installing	-5 ... +40 °C	+23 ... +104 °F		

All the main technical data provided are "manufacturer" values

RoHS  
RoHS

### Accessories

Description	Color	Type	Part Number	Pkg qty	Weight (1 pce) <b>g</b>
Self-adhesive precut blank label compatible with HTP600	White <input type="checkbox"/>	MCLH-R1	1SNK900631R0000	25	10.00
Precut blank label compatible with AMS600	White <input type="checkbox"/>	RCPEB	1SNA178430R0500	1	
Pre-printed cover marker Protection for RCPEB markers	Transparent <input checked="" type="checkbox"/>	EPR1	1SNA178431R2200	1	0.05
Self-adhesive precut blank label compatible with HTP600	White <input type="checkbox"/>	PIB2-TT	1SNA235155R2600	25	9.70
Self-adhesive precut blank label compatible with HTP600	Yellow <input checked="" type="checkbox"/>	PIB2-TT-YL	1SNA235157R2000	25	9.40
Precut blank label compatible with MG3	White <input type="checkbox"/>	MG-TAR 45194	1SNB045194R1735	900	0.62
Self-adhesive precut blank label compatible with MG3	Yellow <input checked="" type="checkbox"/>	MG-TAA 49148	1SNB049148R1735	450	0.91
Self-adhesive precut blank label compatible with MG3	White <input type="checkbox"/>	MG-TAA 49198	1SNB049198R1735	450	0.91
Self-adhesive precut blank label compatible with HTP600	Yellow <input checked="" type="checkbox"/>	MCLH-R1-YL	1SNK900634R0000	25	10.00

Technical data valid for copper conductors only.

### Mounting instructions



# BJCI screw jumper bars

Screw clamp terminal block accessories



1SNL16059R0014

BJC1

## Description

Jumper bar:

- 2, 3, 4, 5 and 10 poles available
- With IP20 protection touchproof
- Composed of captive screw on a jumper bar system
- The 10 poles jumper bar can be adapted to the number of poles required by your application.

## Ordering details

Description	Color	Type	Part Numbers	Pkg qty	Weight (1 pce)	g
5.2 mm 0.205 in spacing	Grey <input type="checkbox"/>	2 poles	BJC15-2	1SNL905602R0000	10	3.95
		3 poles	BJC15-3	1SNL905603R0000	10	5.9
		4 poles	BJC15-4	1SNL905604R0000	10	7.9
		5 poles	BJC15-5	1SNL905605R0000	10	9.87
		10 poles	BJC15-10	1SNL905610R0000	10	19.7
6.2 mm 0.236 in spacing	Grey <input type="checkbox"/>	2 poles	BJC16-2	1SNL906602R0000	10	3.95
		3 poles	BJC16-3	1SNL906603R0000	10	5.9
		4 poles	BJC16-4	1SNL906604R0000	10	7.9
		5 poles	BJC16-5	1SNL906605R0000	10	9.87
		10 poles	BJC16-10	1SNL906610R0000	10	19.7

## Main technical data

Material specifications	Insulating material	Polyamide	
	Flammability	V0	
Ambient temperature min/max	NF F 16 101	I2F2	
	Service IEC 60068-2-1	-55 ... +110 °C	-87 ... +230 °F
	Storage	-55 ... +110 °C	-87 ... +230 °F
	Installing	-5 ... +40 °C	+23 ... +104 °F
RoHS			
RoHS			

## Mounting instructions

①



1 - Standard use

②



2 - Cut extremities

Ensure a good straight cut. by positioning the cutting tool perpendicular to the jumper bar

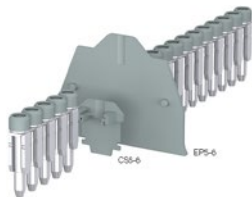

For voltage rating > 50 V and  $U_{imp} > 2.5$  KV, the bellow accessories must be installed between two consecutive jumpers to guarantee IP20 and voltage rating.

1SNL160264S0201 - Rev. A

# PC lateral jumper bars

Screw clamp terminal block accessories



1SNC160265020014

PC

## Description

IP20 Comb jumper bar:

- Direct insertion in the screw clamp before tightening the screws, above the eventual conductor (if conductor used with ferrule, we recommend the use of long ferrule for optimized mounting ergonomony with test disconnect terminal blocks),
- Multiple versions available in pre-cut poles for test disconnect terminal blocks applications.

## Ordering details

Description	Color	Type	Part Numbers	Pkg qty	Weight (1 pce) g	
5.2 mm 0.205 in spacing	Grey <input type="checkbox"/>	2 poles 35 (IEC)	PC6-2	1SNA113546R1400	10	2.00
		3 poles 35 (IEC)	PC6-3	1SNA116536R0500	10	2.00
		4 poles 35 (IEC)	PC6-4	1SNA116537R0600	10	3.00
		10 poles 35 (IEC)	PC6-10	1SNA113548R2600	10	8.00

## Main technical data

Material specifications	Insulating material	Polyamide			
	Flammability	V0			
	NF F 16 101	I2F2			
Ambient temperature min/max	Service IEC 60068-2-1	-55 ... +110 °C	-87 ... +230 °F		
	Storage	-55 ... +110 °C	-87 ... +230 °F		
	Installing	-5 ... +40 °C	+23 ... +104 °F		
	<b>RoHS</b>				
	RoHS				

## Mounting instructions

①



1 - Standard use in case of ATEX application, the lateral jumper bar shall be connected alone (without any conductor) in the clamping unit.

②

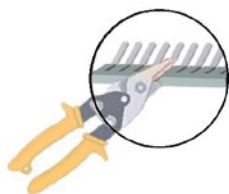

2 - Cut extremities  
Ensure a good straight cut. by positioning the cutting tool perpendicular to the jumper bar

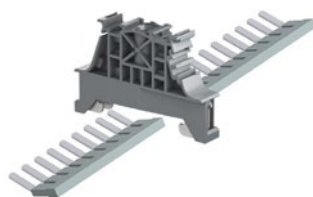

For voltage rating > 50 V and  $U_{imp} > 2.5$  KV, the bellow accessories must be installed between two consecutive jumpers to guarantee IP20 and voltage rating.

Technical data valid for copper conductors only.



## Marking system & accessories

### Contents

HTP600 thermal transfer printer .....	p. 80
AMS plotter .....	p. 82
Terminal block markers.....	p. 83
RC..10 terminal block markers.....	p. 84
RC55, RC65, RCAL85 terminal block markers.....	p. 85

# HTP600 thermal transfer printer

Kit and accessories



## Marking system & accessories

- The All-In-1 printer to mark many labels and markers types,
- Performance,
- High volume and serial production.

### Printer kit

Description	Color	Type	Part Number	Pkg Weight	
				pce	(1 pce) g
Thermal transfer printer KIT		HTP600 KIT	1SNA235720R0000	1	11000.00
<b>List of items included in the KIT</b>					
1 Black ribbon cassette		RIB1-B			
1 Cleaning cassette		HTP500-CLEAN			
1 Support plate for Entrelec terminal block markers		HTP600-PL2M			
1 Support plate for WMTT wire markers		HTP600-PLM			
1 Power support cable					
1 USB cable					



HTP600 KIT

### Feeder kit

Description	Color	Type	Part Number	Pkg Weight	
				pce	(1 pce) g
Universal feeder KIT		HTP600-FEEDER KIT	1SNA235721R0000	1	2560.00
<b>List of items included in the KIT</b>					
1 Universal feeder for marker card		HTP600-FEED			
1 Support plate for Entrelec terminal block markers dedicated to feeder usage		HTP500-PL2			
1 Support plate for WMTT wire markers dedicated to feeder usage		HTP500-PL			
1 Support table to facilitate the cards ejection for feeder		HTP500-BAS			



HTP600-FEEDER KIT

### Feeder and support plates

Description	Color	Type	Part Number	Pkg Weight	
				pce	(1 pce) g
Universal feeder for marker card included in the HTP600-FEEDER KIT	Black ■	HTP600-FEED	1SNA235722R0000	1	530.00
Feeder adapter for WMTT30 Purchased separately	Black ■	HTP600-WMTT30	1SNA235728R0000	1	104.00
Support plate for Entrelec terminal block markers included in the HTP600 KIT	White □	HTP600-PL2M	1SNA235726R0000	1	200.00
Support plate for WMTT wire markers included in the HTP600 KIT	White □	HTP600-PLM	1SNA235724R0000	1	200.00
Support plate for TDM wire markers Purchased separately	White □	HTP600-PL1M	1SNA235725R0000	1	200.00
Support plate for BA4 wire markers Purchased separately	White □	HTP600-BA4M	1SNA235727R0000	1	200.00
Support plate for Entrelec terminal block markers dedicated to feeder usage included in the HTP600-FEEDER KIT	White □	HTP500-PL2	1SNA235705R0600	1	291.00
Support plate for WMTT wire markers dedicated to feeder usage included in the HTP600-FEEDER KIT	White □	HTP500-PL	1SNA235704R0500	1	294.00
Support plate for TDM wire markers dedicated to feeder usage Purchased separately	White □	HTP500-PL1	1SNA235723R0000	1	370.00
Support plate for BA4 wire markers dedicated to feeder usage Purchased separately	White □	HTP500-BA4	1SNA235712R2400	1	290.00
Support plate for other manufactured terminal block markers Purchased separately	White □	HTP500-PL3	1SNA235707R0000	1	130.00



HTP600-FEED



HTP600-WMTT30



HTP600-PL2M



HTP500-PL2



HTP500-PL

# HTP600 thermal transfer printer

Kit and accessories

## Marking system & accessories

### Accessories

Description	Color	Type	Part Number	Pkg		Weight
				pce	(1 pce)	
Black ribbon cassette	Black	RIB1-B	1SNA235734R0000	1		68.00
Blue ribbon cassette	Blue	RIB1-BL	1SNA235732R0000	1		68.00
Green ribbon cassette	Green	RIB1-GN	1SNA235729R0000	1		68.00
Red ribbon cassette	Red	RIB1-RD	1SNA235735R0000	1		69.00
Cleaning cassette		HTP500-CLEAN	1SNA235714R2600	1		83.00
Standard cleaning roll Ø 18		HTP500-ROLL	1SNA235715R2700	1		40.00
Support table to facilitate the cards ejection for feeder included in the HTP600-FEEDER KIT		HTP500-BAS	1SNA235706R0700	1		4060.00



RIB1-...



HTP500-CLEAN



HTP500-ROLL



HTP500-BAS



1SNC16027050201

# AMS plotter

Kit and accessories



AMS 600

## AMS 600

### Description

- For basic marking applications,
- Economic,
- Full-size format,
- Print original manufacturers' markers.

### Ordering details

Description	Color	Type	Part Number	Pkg pce	Weight (1 pce) g
AMS 600 Plotter KIT		AMS 600 KIT	1SNA360000R2400	1	12600
<b>List of items included in the KIT:</b>					
1 AMS 600 plotter pen printer		AMS 600			
1 Software CD		AMS SOFTWARE			
1 Power supply cable		AMS POWER			
1 USB cable		AMS USB			
1 Support plate for RC / MC / RCTT / WMTT / BA4 / RCT		SPRC1			
1 Support plate for MC...PA		SPRC 30-3			
1 Plotter pen Ø 0.25 mm .01 in		AMS PEN 0.25			
1 Plotter pen Ø 0.35 mm .014 in		AMS PEN 0.35			
5 Ink cartridges		AMS INK CARTRIDGES			
1 Cleaner fluid		AMS CLEANER FLUID			
1 Cleaner kit		AMS CLEANER KIT			



AMS 300

## AMS 300

### Description

- Basic needs,
- Economic,
- Half-size format
- Compatible with most of AMS 600 accessories.

### Ordering details

Description	Color	Type	Part Number	Pkg pce	Weight (1 pce) g
AMS 300 Plotter KIT		AMS 300 BASIC KIT	1SNA360000R2500	1	8800
<b>List of items included in the KIT:</b>					
1 AMS 300 plotter pen printer		AMS 300 BASIC			
1 Software CD		AMS SOFTWARE			
1 Power supply cable		AMS POWER			
1 USB cable		AMS USB			
1 Support plate for BA4 / MC / RC / RCAL / RCT / RCTT		SPRC2			
1 Disposable plotter pen Ø 0.25 mm .01 in EDR ink		DISPOSABLE AMS PEN ED-R 0.25			
1 Disposable plotter pen Ø 0.35 mm .014 in EDR ink		DISPOSABLE AMS PEN ED-R 0.35			

# Terminal block markers

Compatible with HTP600 printer

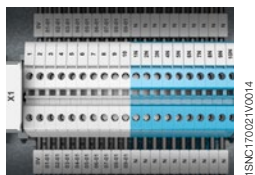

## Blank markers for SNA series

- Blank marker card designated for high marking quality,
- Good marking durability in the severe environments,
- Made of rigid polycarbonate.

Dimensions		Nb. of markers per card	Color	Type	Part Number	Pkg card	Weight (1 card) g
mm	in						

### RC510TT Blank strip Markers for 5 mm 0.197 in spacing terminal blocks and BAZ1 end stop.

5 x 10	0.197 x 0.394	48	White □	RC510TT	1SNA231600R1500	22	12.00
5 x 10	0.197 x 0.394	48	Yellow ■	RC510TT-YL	1SNA231700R1100	22	12.00

### RC610TT Blank strip Markers for 6 mm 0.236 in spacing terminal blocks

6 x 10	0.236 x 0.394	39	White □	RC610TT	1SNA233600R1700	22	12.00
6 x 10	0.236 x 0.394	39	Yellow ■	RC610TT-YL	1SNA233700R1300	22	12.00

### RC810TT Blank strip Markers for 8 mm 0.315 in and larger spacing terminal blocks and end stops

8 x 10	0.315 x 0.394	30	White □	RC810TT	1SNA234600R1000	22	12.00
8 x 10	0.315 x 0.394	30	Yellow ■	RC810TT-YL	1SNA234700R1400	22	12.00

### RCGW510 Blank Individual Marker for Entelec RGW terminal blocks

5 x 10	0.197 x 0.394	45	White □	RCGW510	1SNA235638R0000	12	11.00
--------	---------------	----	---------	---------	-----------------	----	-------

- To be directly used on terminal block assembly,
- Available in precut version to fit all applications.

Dimensions		Nb. of markers per card	Color	Type	Part Number	Pkg card	Weight (1 card) g
mm	in						

### CPMF Blank strip label for Entelec M6/9EE terminal blocks

105 x 7.6	4.134 x 0.299	6	White □	CPMF08105	1SNA235621R0000	22	1.91
-----------	---------------	---	---------	-----------	-----------------	----	------

### CPMF Blank strip label for Entelec series D and ADO terminal blocks

105 x 5.2	4.134 x 0.205	10	White □	CPMF05105	1SNA235618R0000	22	1.91
-----------	---------------	----	---------	-----------	-----------------	----	------

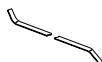
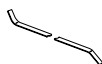
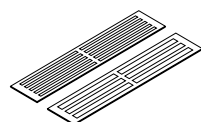
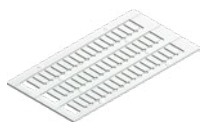

# RC..10 terminal block markers

Compatible with AMS600/300 plotters

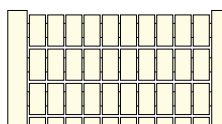

1SNC700141F0000

RC510

## Description

- Blank card in polyamide,
- Terminal blocks are directly independent after strip mounting,
- To be used to mark spring clamp, ADO System® and screw clamp pluggable SNA terminal blocks.

## Main technical data

<b>Material</b>	<b>Flammability</b>
Polyamide	V2

## Ordering details

Dimensions		Maximum printed digits		Nb. of markers per card	Color	Type	Part Number	Pkg	Weight
mm	in	Hor.	Vert.					card	(1 card) g

### For 4 mm 0.157 in terminal block spacing



<b>RC410</b>										
10 x 4	0.394 x 0.157	2	7	100	White	<input type="checkbox"/>	RC410	1SNA229000R1500	10	5.20

### For 5 mm 0.197 in terminal block spacing



<b>RC510</b>										
10 x 5	0.394 x 0.197	3	7	100	White	<input type="checkbox"/>	RC510	1SNA231000R0700	10	5.20
		4	4		Yellow	<input type="checkbox"/>	RC510-YL	1SNA103890R2100		

### For 6 mm 0.236 in terminal block spacing



<b>RC610</b>												
10 x 6	0.394 x 0.236	4	4	100	White	<input type="checkbox"/>	RC610	1SNA233000R0100	10	6.70		
					Blue	<input type="checkbox"/>	RC610	1SNA206233R0000			10	6.70
					Orange	<input type="checkbox"/>	RC610	1SNA206232R0700			10	6.70
					Yellow	<input type="checkbox"/>	RC610	1SNA206231R0600			10	6.70
					Green	<input type="checkbox"/>	RC610	1SNA206230R1100			10	6.70
					Red	<input type="checkbox"/>	RC610	1SNA206235R0200			10	6.70

### For 8 mm 0.315 in terminal block spacing



<b>RC810</b>										
10 x 8	0.394 x 0.315	4	4	100	White	<input type="checkbox"/>	RC810	1SNA234000R0200	10	8.20

### For 10 mm 0.394 in terminal block spacing



<b>RC1010</b>										
10 x 10	0.394 x 0.394	7	7	80	White	<input type="checkbox"/>	RC1010	1SNA238000R1600	10	1.30

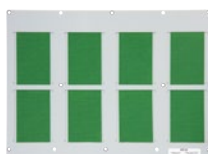

## Marking system accessories

### SPRC 1

#### Support plate for AMS600

Included in KIT MAO AMS 600	SPRC 1	1SNA360010R1500	1	1500.00
-----------------------------	--------	-----------------	---	---------



### SPRC 2

#### Support plate for AMS250

Included in AMS 250 BASIC KIT	SPRC 2	1SNA360011R1500	1	600.00
-------------------------------	--------	-----------------	---	--------

## Mounting instruction





# RC55, RC65, RCAL85 terminal block markers

Compatible with AMS600/300 plotters

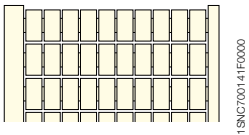

RC55

## Description

- Blank card in polyamide,
- Terminal blocks are directly independent after strip mounting,
- To be used to mark screw clamp (1) and spring clamp (side mounting) SNA terminal blocks, and Miniblocks.

## Main technical data

<b>Material</b>	<b>Flammability</b>
Polyamide	V2

## Ordering details

Dimensions		Maximum printed digits		Nb. of markers per card	Color	Type	Part Number	Pkg	Weight
mm	in	Hor.	Vert.						

### For 5 mm 0.197 in terminal block spacing



#### RC55

5 x 5	0.197 x 0.197	3	3	100	White	RC55	1SNA230000R1200	10	2.90
-------	---------------	---	---	-----	-------	------	-----------------	----	------

### For 6 mm 0.236 in terminal block spacing



#### RC65

5 x 6	0.197 x 0.236	3	3	100	White	RC65	1SNA232000R0000	10	3.60
					Blue	RC65	1SNA103775R0000	10	3.40
					Red	RC65	1SNA103776R0100	10	3.40

### For 8 mm 0.315 in terminal block spacing (1)



#### RCAL85

5 x 8	0.197 x 0.315	5	3	100	White	RCAL85	1SNA237000R0500	10	2.90
-------	---------------	---	---	-----	-------	--------	-----------------	----	------

## Marking system accessories

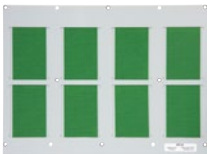

#### SPRC 1

##### Support plate for AMS600

Included in KIT MAO AMS 600	SPRC 1	1SNA360010R1500	1	1500.00
-----------------------------	--------	-----------------	---	---------



#### SPRC 2

##### Support plate for AMS250

Included in AMS 250 BASIC KIT	SPRC 2	1SNA360011R1500	1	600.00
-------------------------------	--------	-----------------	---	--------

(1) RCAL85 not compatible with screw clamp terminal blocks

## Mounting instruction

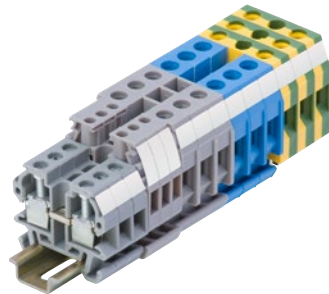

# SNACompact/SNA

## CrossReference table

SNACompact			SNA	
Old PN	New PN	Description	PN	Description
1SNL505010R0000	1SNL605010R0000	C2.5/5	1SNA115486R0300	MA2.5/5
1SNL505020R0000	1SNL605020R0000	C2.5/5.N	1SNA125486R0500	MA2.5/5.N
1SNL506011R0000	1SNL606011R0000	C2.5/6	1SNA115486R0300	MA2.5/5
1SNL506021R0000	1SNL606021R0000	C2.5/6.N	1SNA125486R0500	MA2.5/5.N
1SNL506010R0000	1SNL606010R0000	C4/6	1SNA115116R0700	M4/6
1SNL506020R0000	1SNL606020R0000	C4/6.N	1SNA125116R0100	M4/6.N
1SNL508010R0000	1SNL608010R0000	C6/8	1SNA115118R1100	M6/8
1SNL508020R0000	1SNL608020R0000	C6/8.N	1SNA125118R1300	M6/8.N
1SNL510010R0000	1SNL610010R0000	C10/10	1SNA115120R1700	M10/10
1SNL510020R0000	1SNL610020R0000	C10/10.N	1SNA125120R1100	M10/10.N
1SNL512010R0000	1SNL612010R0000	C16/12	1SNA115129R1400	M16/12
1SNL512020R0000	1SNL612020R0000	C16/12.N	1SNA125129R1600	M16/12.N
1SNL505150R0000	1SNL605150R0000	C2.5/5.P	1SNA165488R2700	MA2.5/5.P
1SNL506151R0000	1SNL606151R0000	C2.5/6.P	1SNA165488R2700	MA2.5/5.P
1SNL506150R0000	1SNL606150R0000	C4/6.P	1SNA165113R1600	M4/6.P
1SNL508150R0000	1SNL608150R0000	C6/8.P	1SNA165114R1700	M6/8.P
1SNL510150R0000	1SNL610150R0000	C10/10.P	1SNA165115R1000	M10/10.P
1SNL512150R0000	1SNL612150R0000	C16/12.P	1SNA165130R2300	M16/12.P
1SNL508310R0000	1SNL608310R0000	C6/8.ST1	1SNA115237R1000	M6/8.ST1
1SNL508311R0000	1SNL608311R0000	C6/8.ST1.IP20	1SNA115971R1000	M6/8.ST1 IP20
1SNL506410R0000	1SNL606410R0000	C4/6.SF	1SNA115657R2500	M4/8.SF
1SNL506411R0000	1SNL606411R0000	C4/6.SFD24	1SNA115935R0400	M4/8.SFD3
1SNL506412R0000	1SNL606412R0000	C4/6.SFD250	1SNA115661R2100	M4/8.SFL
1SNL506310R0000	1SNL606310R0000	C4/6.S	1SNA115986R0000	M4/6.SNB
1SNA115657R2500	1SNL608410R0000	C4/8.SF	1SNA115657R2500	M4/8.SF

# Index

## Part Number classification

Part Number	Type	Page	Part Number	Type	Page	Part Number	Type	Page
1SNA007865R2600	FC2	33, 35, 39, 40, 45, 46, 57	1SNA115935R0400	M4/8.SFD3	56	1SNA173530R2400	CBM5D	32, 34
1SNA008288R1500	FU520	55, 56, 58	1SNA115936R0500	M4/8.D2.SFD3	59	1SNA173627R2100	EL6	13, 14, 34, 36, 37, 46, 58
1SNA008289R1600	FU520	55, 56	1SNA115986R0000	M4/6.SNB	44	1SNA173888R2000	BP8.A4	51
1SNA008290R1300	FU520 1A	55, 56, 58	1SNA116536R0500	PC6-3	11, 12, 43, 53, 54, 78	1SNA174300R1700	PR3.Z2	69
1SNA008291R0000	FU520 2A	55, 56, 58	1SNA116537R0600	PC6-4	11, 12, 43, 53, 54, 78	1SNA176659R1300	ITV5	32
1SNA008292R0100	FU520 5A	55, 56	1SNA116538R1700	PC8-2	15, 45, 49, 50	1SNA176663R0000	BJMI6-2	13, 14
1SNA103189R2600	SCD-WH	40	1SNA116539R1000	PC8-3	45	1SNA176664R0100	BJMI6-3	13, 14
1SNA103775R0000	RC65 BLUE	85	1SNA116540R2500	PC8-4	45	1SNA176665R0200	BJMI6-4	13, 14
1SNA103776R0100	RC65 RED	85	1SNA116576R1500	FEM 3A	13, 24	1SNA176666R0300	BJMI6-5	13, 14
1SNA103890R2100	RC510-YL	84	1SNA116591R0500	FEMS 6D	46	1SNA176667R0400	BJMI6-10	13, 14
1SNA105044R2100	M4/6.D2	34	1SNA116629R2200	FEM4A	14, 25	1SNA176669R1600	BJMI8-2	15, 38, 58
1SNA105045R2200	M4/6.D2	34	1SNA116656R2500	FEM8D1	38	1SNA176670R1300	BJMI8-3	15, 38, 58
1SNA105046R2300	M4/6.D2	34	1SNA116720R2100	SCMA5D	32	1SNA176671R0000	BJMI8-4	15, 38, 58
1SNA105047R2400	M4/6.D2	34	1SNA116771R2000	FED3E	61, 62	1SNA176672R0100	BJMI8-5	15, 38
1SNA105048R0500	M4/6.D2	34	1SNA116795R1100	SCFCV1-2	18	1SNA176673R0200	BJMI8-10	15, 38, 58
1SNA105049R0600	M4/6.D2	34	1SNA116797R1300	SCFCV4	19	1SNA176675R0400	BJMI10-2	16
1SNA105053R2200	M4/6.SNB	44	1SNA116913R0700	FEM8D2S	58	1SNA176676R0500	BJMI10-3	16
1SNA105055R2400	M6/8.SNB	45	1SNA116951R1500	FEM 8S	55, 56	1SNA176677R0600	BJMI10-4	16
1SNA105124R1600	M35/16	18	1SNA117318R2300	FEDR5	65	1SNA176678R1700	BJMI10-5	16
1SNA110106R2500	DR1.5/4	64	1SNA117600R0300	FEDR61	66, 67	1SNA176679R1000	BJMI10-10	16
1SNA110251R0500	DR4/6	66	1SNA118368R1600	FEM6	15-17, 26, 27, 42, 60	1SNA176704R0200	BJMI5DR-2	65
1SNA113003R1000	SCM6	13-17, 38	1SNA118495R1700	SCF6D	34	1SNA176705R0300	BJMI5DR-3	65
1SNA113373R2600	FEM 8	45	1SNA118499R2300	FEM6 D	32, 34, 36, 37	1SNA176706R0400	BJMI5DR-4	65
1SNA113482R0500	SCM6D	34	1SNA118707R0300	SCF6	42	1SNA176708R1600	BJMI5DR-10	65
1SNA113542R1000	PC5-2	10, 32, 42	1SNA120251R0700	DR4/6.N	66	1SNA176736R2100	BJMI5D-2	32
1SNA113544R1200	PC5-10	10, 32, 42	1SNA125124R0100	M35/16.N	18	1SNA176737R2200	BJMI5D-3	32
1SNA113546R1400	PC6-2	11-14, 43, 53, 54, 78	1SNA125166R1300	M4/6.D1.N	35	1SNA176738R0300	BJMI5D-4	32
1SNA113548R2600	PC6-10	11-14, 43, 53, 54, 78	1SNA125271R2400	M4/6.D2.N	34	1SNA176739R0400	BJMI5D-5	32
1SNA113550R2400	EIP	13, 14, 32	1SNA125468R2200	M4/6.3A.N	13	1SNA176740R1100	BJMI5D-10	32
1SNA113629R2700	FEMT2	51	1SNA125479R2500	M4/6.4A.N	14	1SNA176791R2100	CPV4-5	19
1SNA114205R2000	AD 2.5	41, 44, 45, 55, 56	1SNA125490R1500	MA2.5/5.D2.N	32	1SNA176816R1200	CPV1-2	18
1SNA114522R0500	SCFT2	51	1SNA146227R2500	MTC 6.Ex	60	1SNA177812R1700	EL61	61, 62
1SNA114825R0500	SCFM6	28, 42, 44, 45	1SNA160496R2600	DR4/6.P	66, 67	1SNA178024R2500	BJD6-2	61, 62
1SNA114994R0700	FEM62	44	1SNA163043R2100	AL2-H12-M3	13, 14, 39, 58	1SNA178025R2600	BJD6-3	61, 62
1SNA115124R0700	M35/16	18	1SNA163070R0000	AL2-H8.5-M3	35	1SNA178026R2700	BJD6-4	61, 62
1SNA115166R1100	M4/6.D1	35	1SNA163261R0000	AL3-H9.5-M3	13, 14, 35, 39, 58	1SNA178027R2000	BJD6-5	61, 62
1SNA115168R2300	M4/6.DD	36	1SNA163311R2200	PC61-10	34, 36, 37, 40, 44, 46, 66, 67	1SNA178032R2500	BJD6-10	61, 62
1SNA115184R0400	M4/6.DD1	37	1SNA163313R2400	PC8-10	15, 45, 49-51	1SNA178033R2600	BJD6-20	61, 62
1SNA115206R2200	MTC6	60	1SNA163315R2600	PC10-10	16	1SNA178430R0500	RCPEB	76
1SNA115237R1000	M6/8.ST1	51	1SNA164600R1200	PR2	72	1SNA178431R2200	EPR1	76
1SNA115243R2600	M6/8.ST7	51	1SNA164800R0300	PR3.G2	70	1SNA178529R0400	PR50	70
1SNA115271R2200	M4/6.D2	34	1SNA164950R0000	AL2-H9.6-M3	33	1SNA178745R1400	CBM5	42, 44, 60
1SNA115468R2000	M4/6.3A	13	1SNA165111R1400	M35/16.P	18, 29	1SNA179371R1600	CN5	55, 58
1SNA115479R2300	M4/6.4A	14	1SNA165130R2300	M16/12.P	17, 28	1SNA179623R0300	BJDP1	13, 14, 18
1SNA115490R1300	MA2.5/5.D2	32	1SNA167319R0600	AL2-H8.5-M2.6	40	1SNA179624R0400	BJDP2	18
1SNA115498R1700	M6/8.D1	39	1SNA167860R0100	FC4	18, 39, 49, 50	1SNA179625R0500	BJDP3	13, 14
1SNA115501R1200	M6/8.D2	38	1SNA167908R0600	PC51-10	65	1SNA179626R0600	BJMI2-2	17
1SNA115510R1600	DR1.5/5	65	1SNA167927R1000	FC4-1-RD	49-51	1SNA179628R1000	BJMI2-3	17
1SNA115523R0700	M4/8	55	1SNA168500R1200	PR4	71	1SNA179629R1100	BJMI2-4	17
1SNA115530R1200	MA2.5/5.D1.1	33	1SNA168672R1100	TGA8-2	55, 56, 58	1SNA179630R1600	BJMI2-5	17
1SNA115537R0500	D2.5/6.DL	62	1SNA168673R1200	TGA8-3	55, 56, 58	1SNA179631R0300	BJMI2-10	17
1SNA115542R1200	D2.5/6.D	61	1SNA168674R1300	TGA8-4	55, 56, 58	1SNA179668R2000	BJMI6D-2	34, 36, 37, 46
1SNA115561R1500	M4/6.D2.SNBT	46	1SNA168675R1400	ANT	55, 56, 58	1SNA179669R2100	BJMI6D-3	34, 36, 37, 46
1SNA115604R2100	M4/8.D2.SF	58	1SNA168700R2200	PR5	71	1SNA179670R2600	BJMI6D-4	34, 36, 37, 46
1SNA115646R2200	M4/8.D2.SFL	59	1SNA173016R1000	SCDR61-WH	64, 66, 67	1SNA179671R1300	BJMI6D-5	34, 36, 37, 46
1SNA115647R2300	M4/8.D2.SFD	59	1SNA173217R2600	BJM62-2	40, 66	1SNA179672R1400	BJMI6D-10	34, 36, 37, 46
1SNA115661R2100	M4/8.SFL	57	1SNA173218R0700	BJM62-3	40, 66	1SNA179726R0200	AJS9	51
1SNA115663R2300	M4/8.SFD	57	1SNA173219R0000	BJM62-4	40, 66	1SNA195124R0000	M35/16.V0	18
1SNA115665R2500	M4/8.SFDT	57	1SNA173220R0500	PR30	69	1SNA195271R2300	M4/6.D2.V0	34
1SNA115667R2700	M4/8.SFLT	57	1SNA173221R2200	BJM62-5	40	1SNA195490R1400	MA2.5/5.D2.V0	32
1SNA115686R1300	M 4/6.SNB	44	1SNA173226R2700	BJM62-10	40, 66	1SNA195501R1300	M6/8.D2.V0	38
1SNA115688R2500	M6/8.SNB	45	1SNA173523R1100	PC81-10	55, 56, 58	1SNA195637R1200	M4/6.3A.PV0	13, 24
1SNA115699R2000	MA2.5/5.SNB	42				1SNA195638R2300	M4/6.4A.PV0	14, 25
						1SNA195686R1400	M4/6.SNB.V0	44
						1SNA199219R0300	D4/6.T1	41

# Index

## Part Number classification

Part Number	Type	Page	Part Number	Type	Page	Part Number	Type	Page
1SNA199220R0000	D4/6.PT1	41	1SNA235727R0000	HTP600-BA4M	80	1SNK900634R0000	MCLH-R1-YL	76
1SNA199420R2100	BADRL	64-67, 75	1SNA235728R0000	HTP600-WMTT30	80	1SNK900652R0000	SC-JB8-2	51
1SNA205735R0600	BJM4-2	64	1SNA235729R0000	RIB1-GN	81	1SNK900653R0000	SC-JB8-3	51
1SNA205736R0700	BJM4-3	64	1SNA235732R0000	RIB1-BL	81	1SNK900654R0000	SC-JB8-4	51
1SNA205737R0000	BJM4-5	64	1SNA235734R0000	RIB1-B	81	1SNK916302R0000	JB16-2	18
1SNA205738R1100	BJM4-10	64	1SNA235735R0000	RIB1-RD	81	1SNK916303R0000	JB16-3	18
1SNA206230R1100	RC 610 GREEN	84	1SNA237000R0500	RCAL85	85	1SNK916304R0000	JB16-4	18
1SNA206231R0600	RC 610 YELLOW	84	1SNA238000R1600	RC1010	16-20, 27-31, 84	1SNK916305R0000	JB16-5	18
1SNA206232R0700	RC 610 ORANGE	84	1SNA299683R0100	D4/6.T3	40	1SNK916310R0000	JB16-10	18
1SNA206233R0000	RC 610 BLUE	84	1SNA299684R0200	D4/6.T3.P	40	1SNK922302R0000	JB22-2	19
1SNA206235R0200	RC 610 RED	84	1SNA360000R2400	AMS 600 KIT	82	1SNK922303R0000	JB22-3	19
1SNA206596R2500	PR2P	72	1SNA360000R2500	AMS 250 BASIC KIT	82	1SNK922305R0000	JB22-5	19
1SNA206680R1500	AJS9-BK	51	1SNA360010R1500	SPRC 1	84, 85	1SNK922310R0000	JB22-10	19
1SNA206681R0200	AJS9-GN	51	1SNA360011R1500	SPRC 2	84, 85	1SNK926302R0000	JB26-2	20
1SNA206682R0300	AJS9-GR	51	1SNA399726R0700	EPR2	76	1SNK926303R0000	JB26-3	20
1SNA206683R0400	AJS9-BL	51	1SNA400194R2100	M35/16	18	1SNK926305R0000	JB26-5	20
1SNA206720R1400	AJS9-RD	51	1SNA400195R2200	M35/16	18	1SNK926310R0000	JB26-10	20
1SNA206721R0100	AL4-M3	58	1SNA400196R2300	M35/16	18	1SNL605010R0000	C2.5/5	10
1SNA206723R0300	AL4-M4	18	1SNA400305R1000	D70/22	19	1SNL605020R0000	C2.5/5.N	10
1SNA206765R0000	AJS9-WH	51	1SNA400306R1100	D70/22.N	19	1SNL605150R0000	C2.5/5.P	10
1SNA206772R0000	AJS9-PR	51	1SNA400370R2400	D95/26	20	1SNL606010R0000	C4/6	12
1SNA206782R0000	AJS9-BR	51	1SNA400371R1100	D95/26.N	20	1SNL606011R0000	C2.5/6	11
1SNA215580R2100	FED2-4	64	1SNA400620R1700	D95/26.P	20, 31	1SNL606020R0000	C4/6.N	12
1SNA229000R1500	RC 410	64, 84	1SNA400711R0600	PC8-R1	49-51	1SNL606021R0000	C2.5/6.N	11
1SNA230000R1200	RC55	65, 85	1SNA400712R0700	PC8-R2	49-51	1SNL606150R0000	C4/6.P	12, 23
1SNA231000R0700	RC510	10, 21, 32, 42, 84	1SNA400713R0000	PC8-R3	49-51	1SNL606151R0000	C2.5/6.P	22
1SNA231600R1500	RC510TT	10, 32, 42, 83	1SNA400724R0300	PC8-R4	49-51	1SNL606310R0000	C4/6.S	43
1SNA231700R1100	RC510TT-YL	83	1SNA400772R1300	D70/22.P	19, 30	1SNL606410R0000	C4/6.SF	53
1SNA232000R0000	RC65	40, 61, 62, 66, 67, 85	1SNA400791R0000	D95/26.YL	20	1SNL606411R0000	C4/6.SFD24	54
1SNA233000R0100	RC610	11-14, 22-25, 34, 36, 37, 43, 44, 46, 53, 54, 60, 75, 84	1SNA400842R0000	PC8-R5	49, 50	1SNL606412R0000	C4/6.SFD250	54
1SNA233600R1700	RC610TT	11-14, 22-24, 34, 36, 37, 43, 44, 46, 53, 54, 60, 75, 83	1SNA400843R0000	PC8-R6	49, 50	1SNL608010R0000	C6/8	15
1SNA233700R1300	RC610TT-YL	83	1SNA400849R0000	PC8-R7	49, 50	1SNL608020R0000	C6/8.N	15
1SNA234000R0200	RC810	15, 26, 28, 29, 38, 45, 49-51, 55, 56, 58, 84	1SNA400850R0000	PC8-R8	49, 50	1SNL608150R0000	C6/8.P	15, 26
1SNA234600R1000	RC810TT	15-20, 26-31, 38, 45, 49-51, 55, 56, 58, 83	1SNB045194R1735	MG-TAR 45194 (17x35 WH)	76	1SNL608310R0000	C6/8.ST1	49
1SNA234700R1400	RC810TT-YL	83	1SNB045490R8530	MG-TAR 45490 (8,5x30)	76	1SNL608311R0000	C6/8.ST1.IP20	50
1SNA235155R2600	PIB2-TT	76	1SNB049148R1735	MG-TAA 49148 (17x35 YE)	76	1SNL608410R0000	C4/8.SF	55
1SNA235157R2000	PIB2-TT-YL	76	1SNB049198R1735	MG-TAA 49198 (17x35 WH)	76	1SNL610010R0000	C10/10	16
1SNA235158R0100	RCPEAD-TT	76	1SNB049448R8530	MG-TAA 49448 (8,5x30 YE)	76	1SNL610020R0000	C10/10.N	16
1SNA235159R0200	RCPEAD-TT-YL	76	1SNB049498R8530	MG-TAA 49498 (8,5x30 WH)	76	1SNL610150R0000	C10/10.P	16, 27
1SNA235618R0000	CPMF05105	61, 62, 64-67, 83	1SNK140000R0000	MC512	74	1SNL612010R0000	C16/12	17
1SNA235621R0000	CPMF08105	83	1SNK149999R0000	MC512PA	74	1SNL612020R0000	C16/12.N	17
1SNA235638R0000	RCGW510	83	1SNK160000R0000	MC812	73	1SNL900100R0000	EP5-6	10-12, 21-23, 43, 53, 54
1SNA235704R0500	HTP500-PL	80	1SNK169999R0000	MC812PA	73	1SNL900101R0000	CS5-6 (2.5/4mm <sup>2</sup> )	10-12
1SNA235705R0600	HTP500-PL2	80	1SNK900001R0000	BAM4	10-18, 22-29, 42-45, 49-51, 53-56, 73	1SNL900102R0000	EP8-ST	49, 50
1SNA235706R0700	HTP500-BAS	81	1SNK900002R0000	BAZ1	10-18, 22-29, 42-45, 49-51, 53-56, 74	1SNL900201R0000	ST14-YL	49
1SNA235707R0000	HTP500-PL3	80	1SNK900102R0000	BAZH1	19, 20, 30-32, 34, 36-38, 40, 46, 58, 61, 62, 73	1SNL900602R0000	SCB-ST-2P	49, 50
1SNA235712R2400	HTP500-BA4	80	1SNK900604R0000	CO	49, 50	1SNL900602R0000	SCB-kit	49
1SNA235714R2600	HTP500-CLEAN	81	1SNK900605R0000	LH	73, 74, 76	1SNL905602R0000	BJC15-2	10, 77
1SNA235715R2700	HTP500-ROLL	81	1SNK900607R0000	LH-R1	73, 74, 76	1SNL905603R0000	BJC15-3	10, 77
1SNA235720R0000	HTP600 KIT	80	1SNK900611R0000	UMH	73, 74	1SNL905604R0000	BJC15-4	10, 77
1SNA235721R0000	HTP600-FEEDER KIT	80	1SNK900624R0000	KCO	49, 50	1SNL905605R0000	BJC15-5	10, 77
1SNA235722R0000	HTP600-FEED	80	1SNK900630R0000	MCLH	76	1SNL905610R0000	BJC15-10	10, 77
1SNA235723R0000	HTP500-PL1	80	1SNK900633R0000	MCLH-YL	76	1SNL906602R0000	BJC16-2	11, 12, 77
1SNA235724R0000	HTP600-PLM	80				1SNL906603R0000	BJC16-3	11, 12, 77
1SNA235725R0000	HTP600-PL1M	80				1SNL906604R0000	BJC16-4	11, 12, 77
1SNA235726R0000	HTP600-PL2M	80				1SNL906605R0000	BJC16-5	11, 12, 77



---

## CONNECT WITH US

We make it easy to connect with our experts and are ready to provide all the support you need.

Visit [www.te.com/support](http://www.te.com/support) to chat with a Product Information Specialist.

Asia: +86 400-820-6015 - Europe, Middle East, & Africa: +49 6251-133-0 - North America: +1-888-441-9982

---

### te.com

© 2021 TE Connectivity. All Rights Reserved.

TE Connectivity, TE connectivity (logo) and Every Connection Counts are trademarks. All other logos, products and/or company names referred to herein might be trademarks of their respective owners.

While TE has made every reasonable effort to ensure the accuracy of the information in this brochure, TE does not guarantee that it is error-free, nor does TE make any other representation, warranty or guarantee that the information is accurate, correct, reliable or current. TE reserves the right to make any adjustments to the information contained herein at any time without notice. TE expressly disclaims all implied warranties regarding the information contained herein, including, but not limited to, any implied warranties of merchantability or fitness for a particular purpose. The dimensions in this catalog are for reference purposes only and are subject to change without notice. Specifications are subject to change without notice. Consult TE for the latest dimensions and design specifications.

4-1773985-2 03/21 Original

---

### CATALOG

#### TE Connectivity

3, rue Jean Perrin  
69687 Chassieu cedex  
France

Tel: +33 481923100  
[www.te.com](http://www.te.com)