

# Subminiatur NCC

## Serie 670



# NCC

Serie	670
Polzahl	5
Bemessungsstrom	2 A
Bemessungsspannung	50 V
Schutzart	IP54 Flanschdose ungesteckt, IP67 in gestecktem Zustand
Kontaktfläche	Au (Gold)
Anschluss	löten, tauchlöten



## Serie 670 NCC • Kabel- und Flanschsteckverbinder

- Produkteinführung Serie 670 NCC Subminiatur
- Kabelabgang Kabelstecker 3 – 5 mm
- Flanschsteckverbinder mit Löt- und Tauchlötkontakten
- Flanschteile ungesteckt IP54
- IP67 in gestecktem Zustand
- Von vorn und hinten verschraubbar
- > 1000 Steckzyklen
- Bajonettverschluss
- Lieferbar ab sofort

Bezeichnung	Maßzeichnung	Polzahl	Bestell-Nr.
Kabelstecker		5	99 0759 010 05

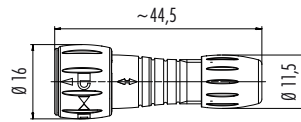

Flanschdose, löten/tauchlöten



**löten**

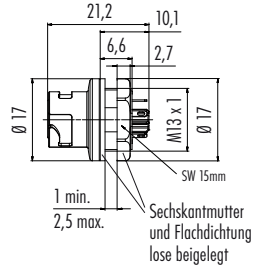

**tauchlöten**

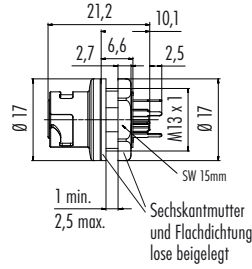

5

09 0762 000 05	löten
09 0762 090 05	tauchlöten

Flanschdose, von vorne verschraubbar, löten/tauchlöten

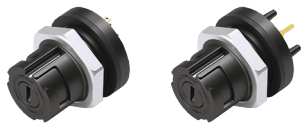

**löten**

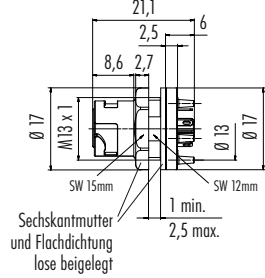

**tauchlöten**

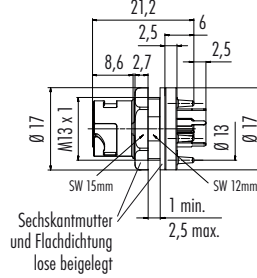

5

09 0762 180 05	löten
09 0762 190 05	tauchlöten

Montageanleitung

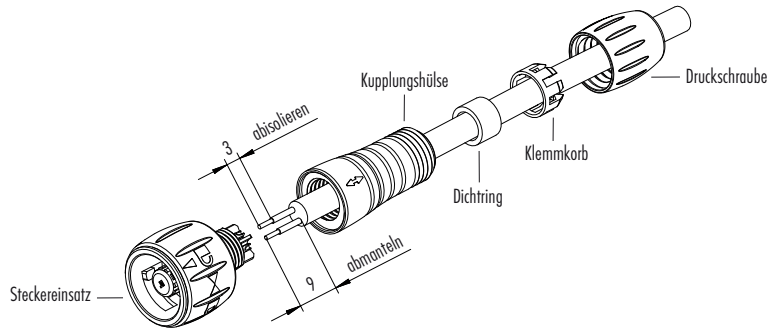

Polbilder	Stifteinsatz (Anschlussseite)	Buchseinsatz (Anschlussseite)	Montageausschnitt	Leiterplattenlayout
-----------	-------------------------------	-------------------------------	-------------------	---------------------

